

JVC

ENGLISH

DIGITAL VIDEO CAMERA

GR-DVM90

Please visit our Homepage on the World Wide Web and answer our Consumer Survey (in English only):

<http://www.jvc-victor.co.jp/english/index-e.html>

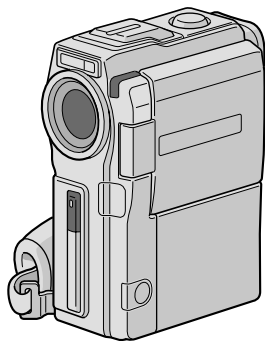

Mini DV NTSC
DSC
DIGITAL
STILL CAMERA

INSTRUCTIONS

For Customer Use:

Enter below the Model No. and Serial No. which is located on the bottom of cabinet. Retain this information for future reference.

Model No. _____

Serial No. _____

CONTENTS

AUTOMATIC DEMONSTRATION 7

GETTING STARTED 8 - 17

RECORDING 18 - 41

Basic Recording For Video 18

Basic Recording For
Digital Still Camera (D.S.C.) 21

Basic Recording For Video And D.S.C. 22

Advanced Features For
Video And D.S.C. 24

PLAYBACK 42 - 57

Basic Playback For Video 42

Advanced Features For Video 43

Basic Playback For D.S.C. 47

Advanced Features For D.S.C. 50

CONNECTIONS 58 - 61

Basic Connections 58

Advanced Connections 60

DUBBING 62 - 65

Dubbing To A VCR 62

Dubbing To Or From A Video Unit
Equipped With A DV Connector 63

Dubbing Images Stored In A
MultiMediaCard To A Tape 64

Dubbing Images Recorded
On A Tape To A MultiMediaCard 65

**USING THE REMOTE
CONTROL UNIT 66 - 77**

Slow-Motion Playback, Frame-By-Frame
Playback and Playback Zoom 68

Playback Special Effects 69

Random Assemble Editing 70

For More Accurate Editing 74

Audio Dubbing 76

Audio Dubbing Using Digital Sound Effects ... 77

USER MAINTENANCE 78

TROUBLESHOOTING 79 - 84

INDEX 85 - 92

Docking Station 85

Controls, Connectors And Indicators 86

Indications 88

CAUTIONS 93 - 95

TERMS 96 - 97

SPECIFICATIONS 98 - 99

LYT0584-001B

EN

Dear Customer,

Thank you for purchasing this digital video camera. Before use, please read the safety information and precautions contained in the following pages to ensure safe use of this product.

Using This Instruction Manual

- All major sections and subsections are listed in the Table Of Contents on the cover page.
- Notes appear after most subsections. Be sure to read these as well.
- Basic and advanced features/operation are separated for easier reference.

It is recommended that you . . .

- refer to the Index (☞ pgs. 85 – 92) and familiarize yourself with button locations, etc. before use.
- read thoroughly the Safety Precautions and Safety Instructions that follow. They contain extremely important information regarding the safe use of this product.

You are recommended to carefully read the cautions on pages 93 through 95 before use.

SAFETY PRECAUTIONS

 <div style="display: inline-block; border: 1px solid black; padding: 2px; text-align: center; font-weight: bold; font-size: small;"> CAUTION RISK OF ELECTRIC SHOCK DO NOT OPEN </div> 
<p>CAUTION: TO REDUCE THE RISK OF ELECTRIC SHOCK, DO NOT REMOVE COVER (OR BACK). NO USER-SERVICEABLE PARTS INSIDE. REFER SERVICING TO QUALIFIED SERVICE PERSONNEL.</p>



The lightning flash with arrowhead symbol, within an equilateral triangle, is intended to alert the user to the presence of uninsulated "dangerous voltage" within the product's enclosure that may be of sufficient magnitude to constitute a risk of electric shock to persons.



The exclamation point within an equilateral triangle is intended to alert the user to the presence of important operating and maintenance (servicing) instructions in the literature accompanying the appliance.

The AA-V51U AC Power Adapter/Charger should be used with:

AC 120 V~, 60 Hz in the USA and Canada,
AC 110 V – 240 V~, 50 Hz/60 Hz in other countries.

CAUTION (applies to the AA-V51U)

TO PREVENT ELECTRIC SHOCK MATCH WIDE BLADE OF PLUG TO WIDE SLOT, FULLY INSERT.

ATTENTION (s'applique à l'AA-V51U)

POUR ÉVITER LES CHOCs ÉLECTRIQUES, INTRODUIRE LA LAME LA PLUS LARGE DE LA FICHE DANS LA BORNE CORRESPONDANTE DE LA PRISE ET POUSSER JUSQU'AU FOND.

WARNING:

TO PREVENT FIRE OR SHOCK HAZARD, DO NOT EXPOSE THIS UNIT TO RAIN OR MOISTURE.

NOTES:

- The rating plate (serial number plate) and safety caution are on the bottom and/or the back of the main unit.
- The rating plate (serial number plate) of the AC Power Adapter/Charger is on its bottom.
- The rating plate (serial number plate) of the Docking Station is on its bottom.

This camcorder is designed to be used with NTSC-type color television signals. It cannot be used for playback with a television of a different standard. However, live recording and LCD monitor/viewfinder playback are possible anywhere. Use the BN-V507U/V514U battery packs and, to recharge them, the provided multi-voltage AC Power Adapter/Charger. (An appropriate conversion adapter may be necessary to accommodate different designs of AC outlets in different countries.)

When the equipment is installed in a cabinet or on a shelf, make sure that it has sufficient space on all sides to allow for ventilation (10 cm (3-15/16") or more on both sides, on top and at the rear).

Do not block the ventilation holes. (If the ventilation holes are blocked by a newspaper, or cloth etc. the heat may not be able to get out.)

No naked flame sources, such as lighted candles, should be placed on the apparatus.

When discarding batteries, environmental problems must be considered and the local rules or laws governing the disposal of these batteries must be followed strictly.

The apparatus shall not be exposed to dripping or splashing.

Do not use this equipment in a bathroom or places with water. Also do not place any containers filled with water or liquids (such as cosmetics or medicines, flower vases, potted plants, cups etc.) on top of this unit. (If water or liquid is allowed to enter this equipment, fire or electric shock may be caused.)

IMPORTANT PRODUCT SAFETY INSTRUCTIONS

Electrical energy can perform many useful functions. But improper use can result in potential electrical shock or fire hazards. This product has been engineered and manufactured to assure your personal safety. In order not to defeat the built-in safeguards, observe the following basic rules for its installation, use and servicing.

ATTENTION:

Follow and obey all warnings and instructions marked on your product and its operating instructions. For your safety, please read all the safety and operating instructions before you operate this product and keep this manual for future reference.

INSTALLATION

1. Grounding or Polarization

(A) Your product may be equipped with a polarized alternating-current line plug (a plug having one blade wider than the other). This plug will fit into the power outlet only one way. This is a safety feature. If you are unable to insert the plug fully into the outlet, try reversing the plug. If the plug should still fail to fit, contact your electrician to replace your obsolete outlet. Do not defeat the safety purpose of the polarized plug.

(B) Your product may be equipped with a 3-wire grounding-type plug, a plug having a third (grounding) pin. This plug will only fit into a grounding-type power outlet. This is a safety feature. If you are unable to insert the plug into the outlet, contact your electrician to replace your obsolete outlet. Do not defeat the safety purpose of the grounding-type plug.

2. Power Sources

Operate your product only from the type of power source indicated on the marking label. If you are not sure of the type of power supply to your home, consult your product dealer or local power company. If your product is intended to operate from battery power, or other sources, refer to the operating instructions.

3. Overloading

Do not overload wall outlets, extension cords, or integral convenience receptacles as this can result in a risk of fire or electric shock.

4. Power Cord Protection

Power supply cords should be routed so that they are not likely to be walked on or pinched by items placed upon or against them, paying particular attention to cords at plugs, convenience receptacles, and the point where they exit from the product.

5. Ventilation

Slots and openings in the cabinet are provided for ventilation. To ensure reliable operation of the product and to protect it from overheating, these openings must not be blocked or covered.

- Do not block the openings by placing the product on a bed, sofa, rug or other similar surface.
- Do not place the product in a built-in installation such as a bookcase or rack unless proper ventilation is provided or the manufacturer's instructions have been adhered to.

6. Wall or Ceiling Mounting

The product should be mounted to a wall or ceiling only as recommended by the manufacturer.

ANTENNA INSTALLATION INSTRUCTIONS

1. Outdoor Antenna Grounding

If an outside antenna or cable system is connected to the product, be sure the antenna or cable system is grounded so as to provide some protection against voltage surges and built-up static charges. Article 810 of the National Electrical Code, ANSI/NFPA 70, provides information with regard to proper grounding of the mast and supporting structure, grounding of the lead-in wire to an antenna discharge unit, size of grounding conductors, location of antenna discharge unit, connection to grounding electrodes, and requirements for the grounding electrode.

2. Lightning

For added protection for this product during a lightning storm, or when it is left unattended and unused for long periods of time, unplug it from the wall outlet and disconnect the antenna or cable system. This will prevent damage to the product due to lightning and power-line surges.

3. Power Lines

An outside antenna system should not be located in the vicinity of overhead power lines or other electric light or power circuits, or where it can fall into such power lines or circuits. When installing an outside antenna system, extreme care should be taken to keep from touching such power lines or circuits as contact with them might be fatal.

EXAMPLE OF ANTENNA GROUNDING AS PER NATIONAL ELECTRICAL CODE, ANSI/NFPA 70

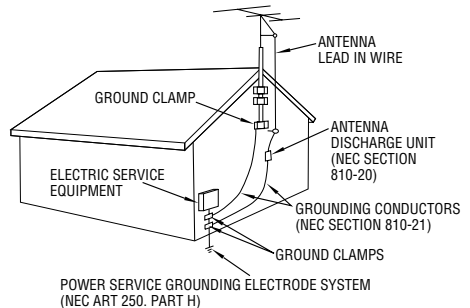

NEC - NATIONAL ELECTRICAL CODE

USE

1. Accessories

To avoid personal injury:

- Do not place this product on an unstable cart, stand, tripod, bracket or table. It may fall, causing serious injury to a child or adult, and serious damage to the product.
- Use only with a cart, stand, tripod, bracket, or table recommended by the manufacturer or sold with the product.
- Use a mounting accessory recommended by the manufacturer and follow the manufacturer's instructions for any mounting of the product.
- Do not try to roll a cart with small casters across thresholds or deep-pile carpets.

2. Product and Cart Combination

A product and cart combination should be moved with care. Quick stops, excessive force, and uneven surfaces may cause the product and cart combination to overturn.

PORTABLE CART WARNING
(Symbol provided by RETAC)



3. Water and Moisture

Do not use this product near water—for example, near a bath tub, wash bowl, kitchen sink or laundry tub, in a wet basement, or near a swimming pool and the like.

4. Object and Liquid Entry

Never push objects of any kind into this product through openings as they may touch dangerous voltage points or short-out parts that could result in a fire or electric shock. Never spill liquid of any kind on the product.

5. Attachments

Do not use attachments not recommended by the manufacturer of this product as they may cause hazards.

6. Cleaning

Unplug this product from the wall outlet before cleaning. Do not use liquid cleaners or aerosol cleaners. Use a damp cloth for cleaning.

7. Heat

The product should be situated away from heat sources such as radiators, heat registers, stoves, or other products (including amplifiers) that produce heat.

SERVICING

1. Servicing

If your product is not operating correctly or exhibits a marked change in performance and you are unable to restore normal operation by following the detailed procedure in its operating instructions, do not attempt to service it yourself as opening or removing covers may expose you to dangerous voltage or other hazards. Refer all servicing to qualified service personnel.

2. Damage Requiring Service

Unplug this product from the wall outlet and refer servicing to qualified service personnel under the following conditions:

- When the power supply cord or plug is damaged.
- If liquid has been spilled, or objects have fallen into the product.
- If the product has been exposed to rain or water.
- If the product does not operate normally by following the operating instructions. Adjust only those controls that are covered by the operating instructions as an improper adjustment of other controls may result in damage and will often require extensive work by a qualified technician to restore the product to its normal operation.
- If the product has been dropped or damaged in any way.
- When the product exhibits a distinct change in performance—this indicates a need for service.

3. Replacement Parts

When replacement parts are required, be sure the service technician has used replacement parts specified by the manufacturer or have the same characteristics as the original part. Unauthorized substitutions may result in fire, electric shock or other hazards.

4. Safety Check

Upon completion of any service or repairs to this product, ask the service technician to perform safety checks to determine that the product is in safe operating condition.

SAFETY PRECAUTIONS

Do not point the lens or the viewfinder directly into the sun. This can cause eye injuries, as well as lead to the malfunctioning of internal circuitry. There is also a risk of fire or electric shock.

CAUTION!

The following notes concern possible physical damage to the camcorder and to the user.

When carrying, be sure to always securely attach and use the provided shoulder strap. Carrying or holding the camcorder by the viewfinder and/or the LCD monitor can result in dropping the unit, or in a malfunction.

Take care not to get your finger caught in the cassette holder cover. Do not let children operate the camcorder, as they are particularly susceptible to this type of injury.

Do not use a tripod on unsteady or unlevel surfaces. It could tip over, causing serious damage to the camcorder.

CAUTION!

Attaching the camcorder to the Docking Station with cables (Audio/Video, S-Video, Editing, DC, etc.) connected, then leaving it on top of the TV is not recommended, as tripping on the cables will cause the camcorder to fall, resulting in damage.

Mini **DV** NTSC *MultiMediaCard*

- This camcorder is designed exclusively for the digital video cassette and MultiMediaCard. Only cassettes marked "Mini **DV**" and memory cards marked "MultiMediaCard" can be used with this unit.

Before recording an important scene . . .

- make sure you only use cassettes with the Mini DV mark **Mini DV**.
- make sure you only use memory cards with the mark *MultiMediaCard*.
- remember that this camcorder is not compatible with other digital video formats.
- remember that this camcorder is intended for private consumer use only. Any commercial use without proper permission is prohibited. (Even if you record an event such as a show, performance or exhibition for personal enjoyment, it is strongly recommended that you obtain permission beforehand.)

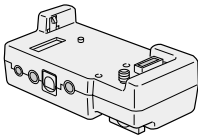

• Docking Station
CU-V502U

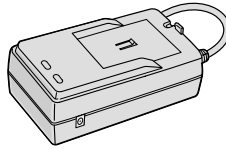

• AC Power Adapter/Charger
AA-V51U

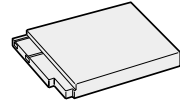

• Battery Pack BN-V507U

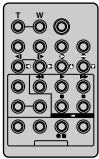

• Remote Control Unit
RM-V716U

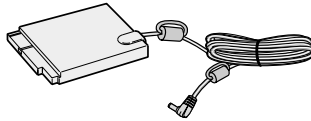

• DC Cord

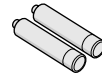

• AAA (R03) Battery x 2
(for remote control unit)

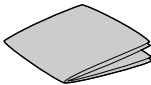

• Cleaning Cloth

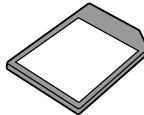

• MultiMediaCard (8 MB)
(Already inserted in the
camcorder)

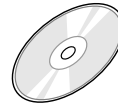

• CD-ROM
The CD ROM contains the
following 11 software programs:

- MultiMediaNavigator
- JLIP Video Capture
- JLIP Video Producer
- Picture Navigator (for Windows®)
- Picture Navigator (for Macintosh®)
- CardNavigator
- Video Player
- JVC Video Decoder

- Mr. Photo Gold
- Mr. Photo
- PhotoAlbum
- Prolmage Plus



• Audio/Video Cable
(ø3.5 mini-plug to
RCA plug)

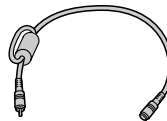

• Audio Cable x 2
(for connection of
an optional external
microphone and
headphones)

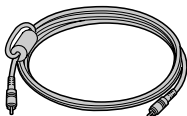

• Editing Cable (One plug has
3 rings around the pin, and the
other has 1 ring around the pin.)



• JLIP Cable (Both plugs have
3 rings around the pin.)



• PC Connection Cable

How To Use Audio Cables

When using an optional external microphone or headphones, connect to the provided Audio cable (with a core filter attached), then connect the Audio cable to the camcorder. The core filter reduces interference.

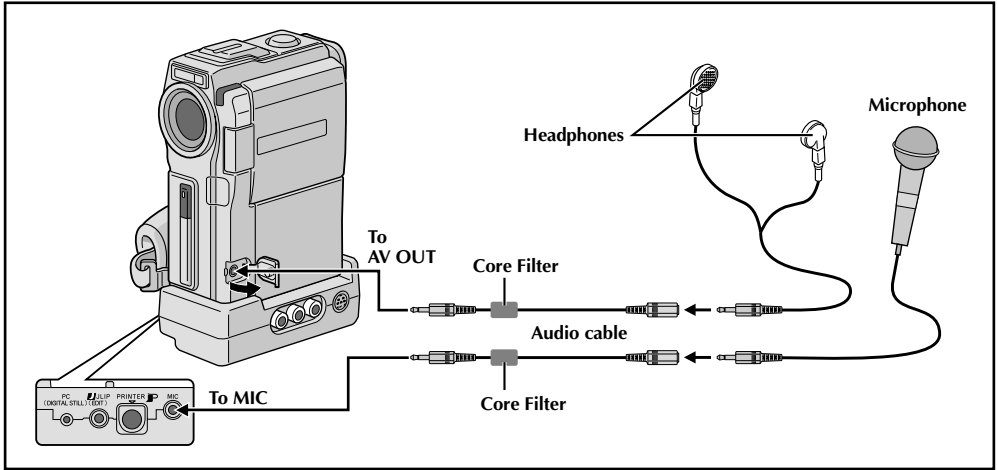

AUTOMATIC DEMONSTRATION

Automatic Demonstration takes place when “**DEMO. MODE**” is set to “**ON**” (factory-preset).

- Available when the **POWER** Switch is set to “**CAMERA**” and no cassette is in the camcorder.
- Performing any operation during the demonstration stops the demonstration temporarily. If no operation is performed for more than 1 minute after that, the demonstration will resume.
- “**DEMO. MODE**” remains “**ON**” even if the camcorder power is turned off.
- To cancel Automatic Demonstration, set the Operation Switch to “**M**” and set the **POWER** Switch to “**CAMERA**” while pressing down the Lock Button located on the switch, then press the **MENU** wheel twice while the demo is in progress. This takes you directly to the demo mode’s Setting Menu (so you will not have to go through the Menu Screen). Rotate the **MENU** wheel to select “**OFF**” and press it. The normal screen appears.

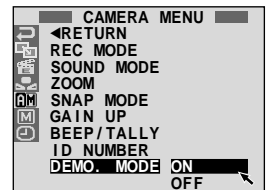
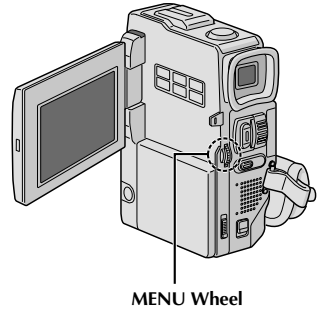

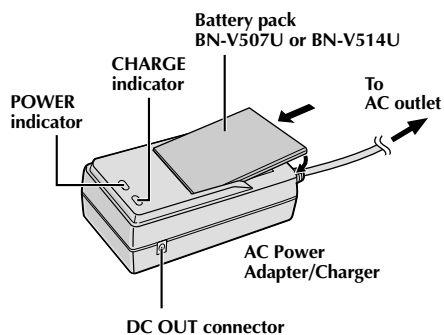

Battery pack	Charging time
BN-V507U	approx. 1 hr. 30 min.
BN-V514U (optional)	approx. 3 hrs.

Power

This camcorder's 2-way power supply system lets you choose the most appropriate source of power. Do not use provided power supply units with other equipment.

CHARGING THE BATTERY PACK

- 1 Make sure you unplug the camcorder's DC cord from the AC Power Adapter/Charger. Plug the AC Adapter/Charger's power cord into an AC outlet. The POWER indicator lights.
- 2 Attach the battery pack with the \oplus \ominus mark aligned with the corresponding marks on the AC Power Adapter/Charger. The CHARGE Indicator begins blinking to indicate charging has started.
- 3 When the CHARGE indicator stops blinking but stays lit, charging is finished. Pull the battery out. Remember to unplug the AC Adapter/Charger's power cord from the AC outlet.

NOTES:

- Perform charging where the temperature is between 10°C and 35°C (50°F and 95°F). 20°C to 25°C (68°F to 77°F) is the ideal temperature range for charging. If the environment is too cold, charging may be incomplete.
- Charging times noted above are for a fully discharged battery pack.
- Charging time varies according to the ambient temperature and the status of the battery pack.
- To avoid interference with reception, do not use the AC Power Adapter/Charger near a radio.
- If you connect the camcorder's DC cord to the adapter during battery charging, power is supplied to the camcorder and charging stops.
- Since the AC Power Adapter/Charger processes electricity internally, it becomes warm during use. Be sure to use it only in well-ventilated areas.
- When charging the battery pack for the first time or after a long storage period, the CHARGE indicator may not light. In this case, remove the battery pack from the AC Power Adapter/Charger, then try charging again.
- If the battery operation time remains extremely short even after having been fully charged, the battery is worn out and needs to be replaced. Please purchase a new one.

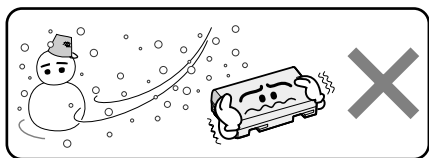

Lithium-ion is vulnerable in colder temperatures.



About Batteries

DANGER! Do not attempt to take the batteries apart, or expose them to flame or excessive heat, as it may cause a fire or explosion.

WARNING! Do not allow the battery or its terminals to come in contact with metals, as this can result in a short circuit and possibly start a fire.

The Benefits Of Lithium-Ion Batteries

Lithium-ion battery packs are small but have a large power capacity. However, when one is exposed to cold temperatures (below 10°C/50°F), its usage time becomes shorter and it may cease to function. If this happens, place the battery pack in your pocket or other warm, protected place for a short time, then re-attach it to the camcorder. As long as the battery pack itself is not cold, it should not affect performance.

(If you're using a heating pad, make sure the battery pack does not come in direct contact with it.)

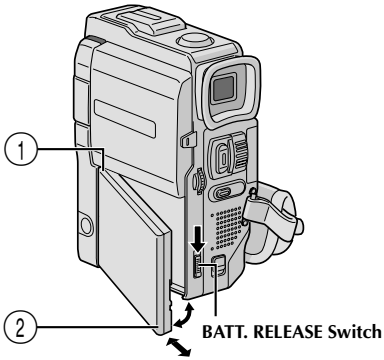
**ATTENTION:**

Before detaching the power source, make sure that the camcorder's power is turned off. Failure to do so can result in a camcorder malfunction.

INFORMATION:

VU-V856KIT is a set composed of the BN-V856U battery pack and AA-V80U AC Power Adapter/Charger. Read the VU-V856KIT's instruction manuals before using. It is impossible to charge the BN-V856U battery pack using the provided AC Power Adapter/Charger. Use the optional AA-V80U AC Power Adapter/Charger.

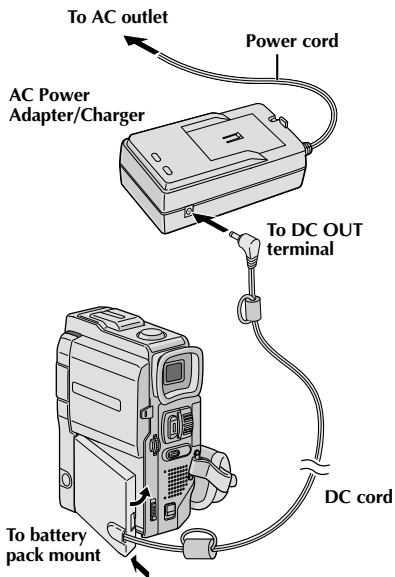
**USING THE BATTERY PACK**

1 Insert the terminal end ① of the battery pack into the battery pack mount, then firmly push the end ② of the battery pack in the direction of the arrow until it locks into place as shown in the illustration.

- If the battery pack is attached in the wrong position, a malfunction may occur.

To Detach The Battery Pack. . .

.... while sliding down **BATT. RELEASE**, detach it.

Approximate recording time

Battery pack	LCD monitor on/ Viewfinder off	LCD monitor off/ Viewfinder on
BN-V507U	50 min.	1 hr.
BN-V514U (optional)	1 hr. 45 min.	2 hrs. 5 min.
BN-V856U (optional)	7 hrs.	8 hrs. 30 min.

NOTES:

- Recording time is reduced significantly under the following conditions:
 - Zoom or Record-Standby mode is engaged repeatedly.
 - The LCD monitor is used repeatedly.
 - The playback mode is engaged repeatedly.
- Before extended use, it is recommended that you prepare enough battery packs to cover 3 times the planned shooting time.

USING AC POWER

Use the AC Power Adapter/Charger (connect as shown in the illustration).

NOTES:

- The provided AC Power Adapter/Charger features automatic voltage selection in the AC range from 110 V to 240 V.
- For other notes, see pg. 8.

Grip Adjustment

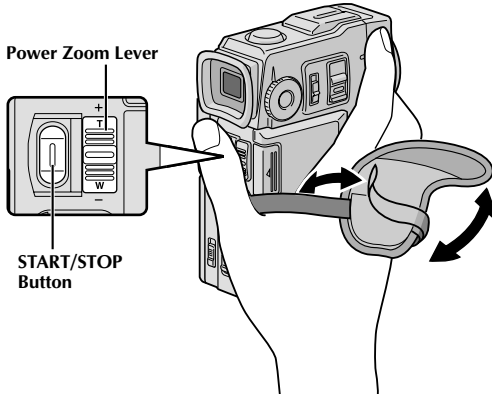

- 1 Separate the Velcro strip.
- 2 Pass your right hand through the loop and grasp the grip.
- 3 Adjust so that your thumb and fingers can easily operate the **START/STOP** Button and Power Zoom Lever. Refasten the Velcro strip.

Viewfinder Adjustment

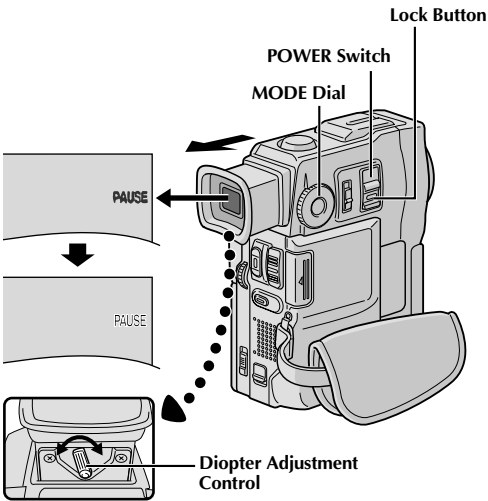

- 1 Set the **POWER** Switch to "**CAMERA**" while pressing down the **Lock Button** located on the switch and set the **MODE** Dial to any position.
- 2 Pull out the viewfinder fully.
- 3 Turn the **Diopter Adjustment Control** until the indications in the viewfinder are clearly focused.

Tripod Mounting

- 1 Align the screw on the tripod with the camera's mounting socket. Then tighten the screw.

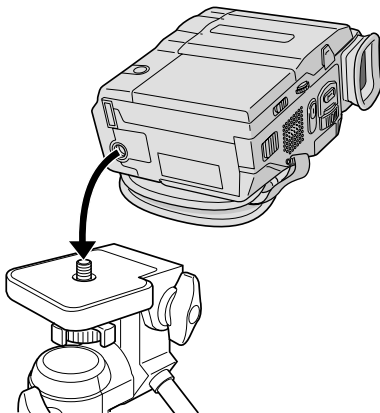

CAUTION:

When using a tripod, be sure to open and extend its legs fully to stabilize the camcorder. To prevent damage to the unit caused by falling over, do not use a small-sized tripod.

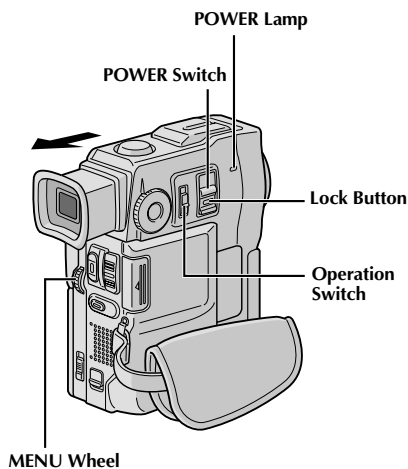

Display

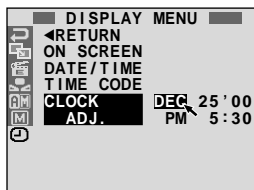
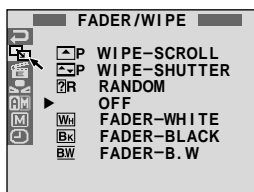

DISPLAY MENU

Date/Time Settings

The date/time is recorded onto the tape at all times, but its display can be turned on or off during playback (▶ pg. 43).

- 1** Set the Operation Switch to "CAMERA" and set the **POWER** Switch to "CAMERA" while pressing down the Lock Button located on the switch, then open the LCD monitor fully or pull out the viewfinder fully. The **POWER** lamp lights and the camcorder is turned on.
- 2** Press the **MENU** wheel. The Menu Screen appears.
- 3** Rotate the **MENU** wheel to select "CAMERA". Press it and "DISPLAY MENU" appears.
- 4** Rotate the **MENU** wheel to select "CLOCK ADJ.". Press it and "month" is highlighted. Rotate the **MENU** wheel to input the month. Press it. Repeat to input the day, year, hour and minute. Rotate the **MENU** wheel to select "◀RETURN", and press it twice. The Menu Screen closes.

Built-in Clock's Rechargeable Lithium Battery

To store the date/time in memory, the clock's rechargeable lithium battery is integrated in the camcorder. While the camcorder is connected to an AC outlet using the AC Power Adapter/Charger, or while the battery pack attached to the camcorder continues to supply power, the clock's rechargeable lithium battery is always charged. However, if the camcorder is not used for approx. 3 months, the clock's lithium battery will become discharged and the date/time stored in memory will be lost. When this occurs, first connect the camcorder to an AC outlet using the AC Power Adapter/Charger for over 24 hours to charge the clock's rechargeable lithium battery. Then perform the date/time setting before using the camcorder. Note that the camcorder can be used without setting the date/time.

NOTE:

Even if you select "CLOCK ADJ.", if the parameter is not highlighted the camcorder's internal clock continues to operate. Once you move the highlight bar to the first date/time parameter (month), the clock stops. When you finish setting the minute and press the **MENU** wheel, the date and time begin operation from the date and time you just set.

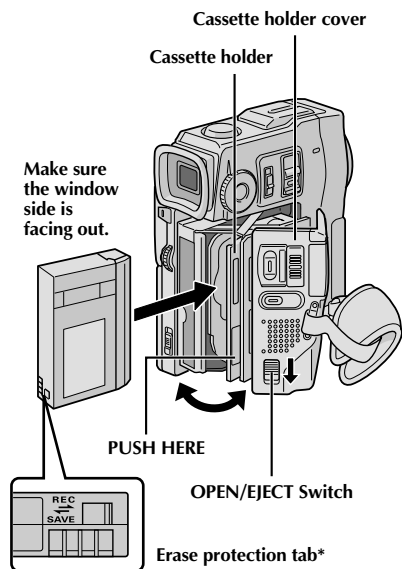

Loading/Unloading A Cassette

The camcorder needs to be powered up to load or eject a cassette.

- 1** Slide down and hold **OPEN/EJECT** in the direction of the arrow then pull the cassette holder cover open until it locks. The cassette holder opens automatically.
 - Do not touch internal components.
- 2** Insert or remove a tape and press "PUSH HERE" to close the cassette holder.
 - Once the cassette holder is closed, it recedes automatically. Wait until it recedes completely before closing the cassette holder cover.
 - When the battery's charge is low, you may not be able to close the cassette holder cover. Do not apply force. Replace the battery with a fully charged one before continuing.
- 3** Close the cassette holder cover firmly until it locks into place.

* To Protect Valuable Recordings . . .

... slide the erase protection tab on the back of the tape in the direction of "SAVE". This prevents the tape from being recorded over. To record on this tape, slide the tab back to "REC" before loading it.

Approximate recording time

Tape	Recording mode	
	SP	LP
30 min.	30 min.	45 min.
60 min.	60 min.	90 min.
80 min.	80 min.	120 min.

NOTES:

- It takes a few seconds for the cassette holder to open. Do not apply force.
- If you wait a few seconds and the cassette holder does not open, close the cassette holder cover and try again. If the cassette holder still does not open, turn the camcorder off then on again.
- If the tape does not load properly, open the cassette holder cover fully and remove the cassette. A few minutes later, insert it again.
- When the camcorder is suddenly moved from a cold place to a warm environment, wait a short time before opening the cassette holder cover.
- Closing the cassette holder cover before the cassette holder comes out may cause damage to the camcorder.
- Even when the camcorder is switched off, a cassette can be loaded or unloaded. After the cassette holder is closed with the camcorder switched off, however, it may not recede. It is recommended to turn the power on before loading or unloading.
- When resuming recording, once you open the cassette holder cover a blank portion will be recorded on the tape or a previously recorded scene will be erased (recorded over) regardless of whether the cassette holder came out or not. See page 23 for information about recording from the middle of a tape.

Recording Mode Setting

Set the tape recording mode depending on your preference.

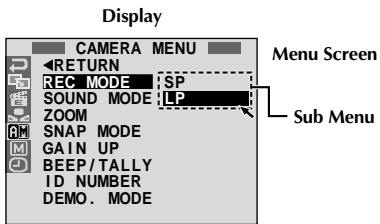
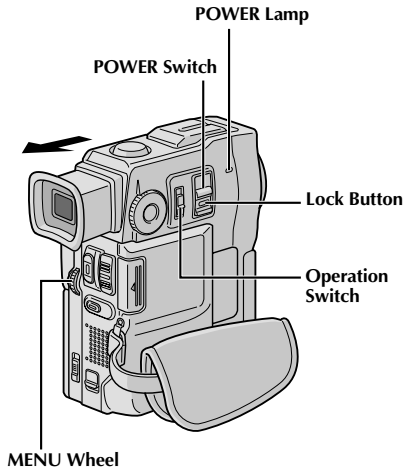

1 Set the Operation Switch to "M" and set the **POWER** Switch to "CAMERA" while pressing down the Lock Button located on the switch, then open the LCD monitor fully or pull out the viewfinder fully. The POWER lamp lights and the camcorder is turned on.

2 Press the **MENU** wheel. The Menu Screen appears.

3 Rotate the **MENU** wheel to select "CAMERA MENU" and press it.

4 Rotate the **MENU** wheel to select "REC MODE" and press it. The Sub Menu appears. Select "SP" or "LP" by rotating the **MENU** wheel and press it. Rotate the **MENU** wheel to select "RETURN", and press it twice. The Menu Screen closes.

- Audio Dubbing (pg. 76) is impossible on a tape recorded in the LP mode.
- "LP" (Long Play) is more economical, providing 1.5 times the recording time.

NOTES:

- If the recording mode is switched during recording, the playback picture will be blurred at the switching point.
- It is recommended that tapes recorded in the LP mode on this camcorder be played back on this camcorder.
- During playback of a tape recorded on another camcorder, blocks of noise may appear or there may be momentary pauses in the sound.

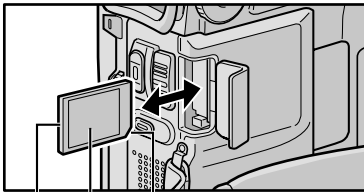
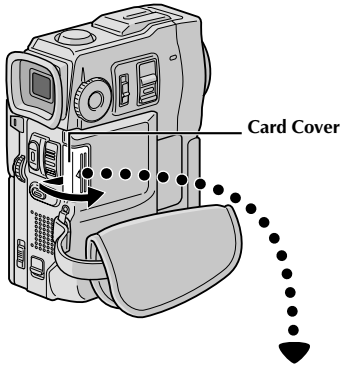

Label
MultiMediaCard

Loading A MultiMediaCard

The provided MultiMediaCard is already inserted in the camcorder when you receive the camcorder.

- 1 Make sure the camcorder's power is off.
- 2 Open the card cover.
- 3 Insert the MultiMediaCard clipped edge first.
 - Do not touch the terminal on the reverse side of the label.
- 4 To close the card cover, push it until you hear a click.

NOTES:

- Be sure to use only MultiMediaCards marked "MultiMediaCard".
- Some brands of MultiMediaCards are not compatible with this camcorder. Before purchasing a MultiMediaCard, consult its manufacturer or dealer.

To Unload A MultiMediaCard . . .

.... in step 3 push the MultiMediaCard, which then comes out of the camcorder automatically. Pull it out and close the card cover.

ATTENTION:

Do not insert/remove the MultiMediaCard while the camcorder is turned on, as this may cause the MultiMediaCard to be corrupted or cause the camcorder to become unable to recognize whether or not the card is installed.

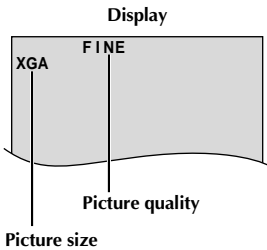
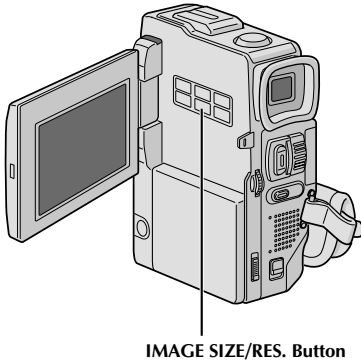
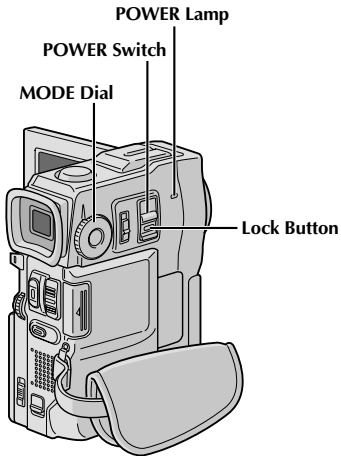

Picture Quality/Size Mode Setting

Picture quality and size can be selected to best match your needs. Four different modes are available: XGA (1024 x 768 pixels) FINE, XGA STD, VGA (640 x 480 pixels) FINE and VGA STD, listed in order of quality.

- 1 Set the **POWER** Switch to "**CAMERA**" while pressing down the Lock Button located on the switch and set the **MODE** Dial to "**DSC**", then open the LCD monitor fully. The POWER lamp lights and the camcorder is turned on.
- 2 Press **IMAGE SIZE/RES.** until the desired mode appears.

Approximate Number of Storable Images

Picture Quality/Size Mode	MultiMediaCard		
	4 MB (optional)	8 MB (provided, with Sound Effects pre-stored)	8 MB (optional)
XGA FINE	12	21	24
XGA STD	36	64	75
VGA FINE	26	46	54
VGA STD	76	133	155

NOTES:

- The number of storable images depends on the selected Picture Quality/Size mode as well as the composition of the subjects in the images.
- When the **MODE** Dial is set to "**DUAL**", only the picture quality can be set.

To turn on the camcorder, set the **POWER Switch** to any operation mode except "OFF" while pressing down the **Lock Button** located on the switch.

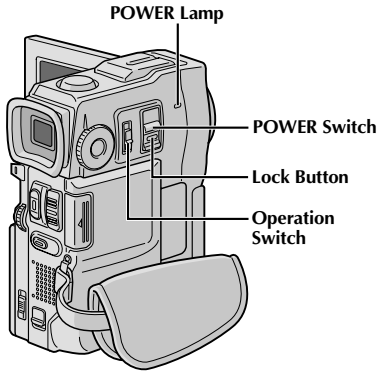

When the **POWER Switch** is set to "**MEMORY PLAY**", the type of file (**IMAGE**, **E-MAIL CLIP** or **SOUND**) is displayed. When set to "**CAMERA**" or "**PLAY/PC**", there is no indication.



When the **Operation Switch** is set to "**A**", "F. AUTO" appears. When set to "**M**", there is no indication.



Operation Mode

Choose the appropriate operation mode according to your preference using the **POWER Switch**, **Operation Switch** and **MODE Dial**.

POWER Switch Position	
CAMERA :	Allows you to record on a tape or in the MultiMediaCard.
OFF :	Allows you to switch off the camcorder.
PLAY/PC :	Allows you to play back a recording on the tape or to transfer a still image recorded on the tape or in the MultiMediaCard to a computer.
MEMORY PLAY :	Allows you to display an image stored in the MultiMediaCard.

Operation Switch Position	
M (Manual):	Allows you to set various recording functions using the Menus. If you want more creative capabilities than Full Auto recording, try this mode.
A (Full Auto):	Allows you to record using NO special effects or manual adjustments. Suitable for standard recording.

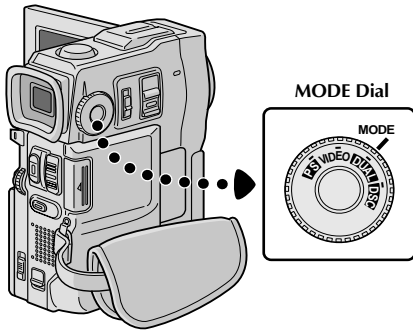

The following indications appear in the upper left corner, depending on the **MODE** Dial position.

DUAL
<p>DUAL : When set to " DUAL "</p> <p>No display : When set to " VIDEO "</p> <p>PS : When set to " PS "</p> <p>XGA or VGA : When set to " DSC "</p>

MODE Dial Position	Function
DUAL	<ul style="list-style-type: none"> • Allows you to record video on a tape and store still images in a MultiMediaCard simultaneously (☞ pg. 26). • File size of still images: 640 x 480 pixels • Video quality is the same as in the VIDEO mode.
VIDEO	<ul style="list-style-type: none"> • Allows you to record video and still images on a tape. Approx. 6 seconds of a still image is inserted between video recordings (☞ pg. 20). • Zoom magnification over 10X is available (☞ pg. 22, 29).
PS (Progressive mode)	<ul style="list-style-type: none"> • Allows you to record moving images (successive jitter-free still images) with superior quality on a tape (☞ pg. 24). The still images can also be processed on a PC or printed out. • Zoom magnification over 10X is available (☞ pg. 22, 29). • Playback of images recorded in this mode is not smooth.
DSC	<ul style="list-style-type: none"> • Allows you to record still images in a MultiMediaCard (☞ pg. 15, 21). • File size: 1024 x 768 pixels (XGA), 640 x 480 pixels (VGA)

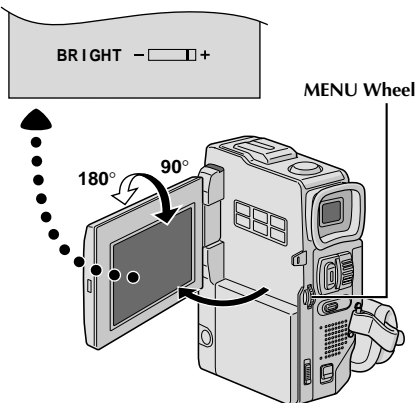
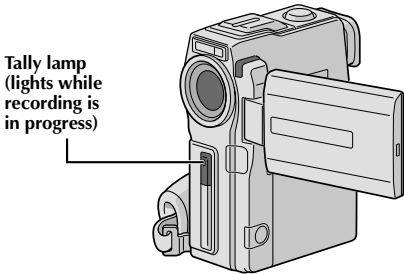
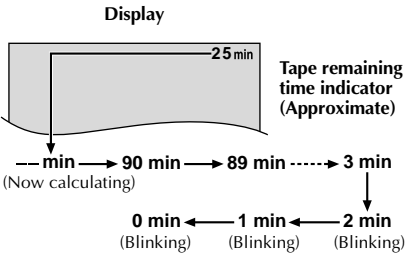
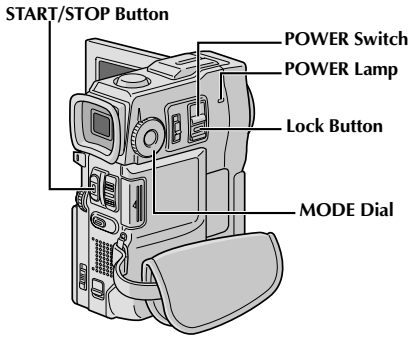

NOTE:

You should already have performed the procedures listed below. If not, do so before continuing.

- Power (☞ pg. 8)
- Grip Adjustment (☞ pg. 10)
- Viewfinder Adjustment (☞ pg. 10)
- Load A Cassette (☞ pg. 12)
- Recording Mode Setting (☞ pg. 13)

1 Set the **MODE Dial** to "VIDEO" and set the **POWER Switch** to "**CAMERA**" while pressing down the **Lock Button** located on the switch.

Shooting while using the viewfinder: Make sure the LCD monitor is closed and locked. Pull out the viewfinder fully.

- Be sure to pull out the viewfinder until you hear a click, otherwise it may be pushed back in during use.

Shooting while using the LCD monitor: Make sure the viewfinder is pushed back in. Open the LCD monitor fully.

- The **POWER lamp** lights and the camcorder enters the Record-Standby mode. "PAUSE" is displayed.

2 Press **START/STOP**. "REC" appears while recording is in progress.

To Stop Recording . . .

.... press **START/STOP**. The camcorder re-enters the Record-Standby mode.

To Adjust The Brightness Of The Display

.... rotate the **MENU wheel** until the bright level indicator on the display moves and the appropriate brightness is reached.

- It is also possible to adjust the brightness of the viewfinder.

NOTES:

- When you use the LCD monitor outdoors in direct sunlight, the LCD monitor may be difficult to see. If this happens, use the viewfinder instead.
- The image will not appear simultaneously in the LCD monitor and the viewfinder.
- The cassette holder cannot be opened unless a power supply is attached.
- There may be a delay after you open the cassette holder cover until the cassette holder opens. Do not use force.
- Once the cassette holder is closed, it recedes automatically. Wait until it recedes completely before closing the cassette holder cover.
- The time required to calculate and display the remaining tape length, and the accuracy of the calculation, may vary according to the type of tape used.
- "TAPE END" appears when the tape reaches its end, and the power goes off automatically if left in this condition for 5 minutes. "TAPE END" also appears when a cassette at its end is loaded.
- If the Record-Standby mode continues for 5 minutes, the camcorder's power shuts off automatically. To turn the camcorder on again, push back and pull out the viewfinder again or close and re-open the LCD monitor.
- When a blank portion is left between recorded scenes on the tape, the time code is interrupted and errors may occur when editing the tape. To avoid this, refer to "Recording from the middle of a tape" (☞ pg. 23).
- During recording, sound is not heard from the speaker. To hear the sound, connect optional headphones to the headphone connector. The sound volume is at the level it was adjusted to during playback (☞ pg. 42).
- **To turn the tally lamp off during recording,** ☞ pg. 28, 29.
- **To remove the indications from the camcorder's display during recording,** ☞ pg. 28, 31.

**JOURNALISTIC SHOOTING**

In some situations, different shooting angles may provide more dramatic results. Hold the camcorder in the desired position and tilt the LCD monitor in the most convenient direction. It can rotate 270° (90° downward, 180° upward).

SELF-RECORDING

You can shoot yourself while viewing your own image in the LCD monitor. Open the LCD monitor and tilt it upward 180° so that it faces forward, then point the lens toward yourself and start recording.

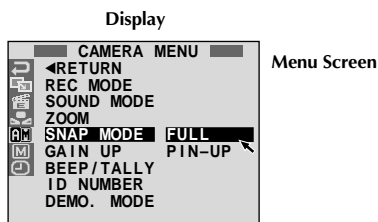
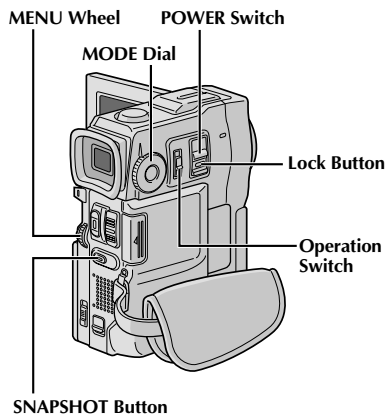

Snapshot (For Video Recording)

This feature lets you record still images that look like photographs onto a tape.

SNAPSHOT MODE SELECTION

- 1 Set the **POWER** Switch to "CAMERA" while pressing down the Lock Button located on the switch and the **MODE** Dial to "VIDEO" or "PS", then set the Operation Switch to "M". Pull out the viewfinder fully or open the LCD monitor fully.
- 2 Press the **MENU** wheel. The Menu Screen appears.
- 3 Rotate the **MENU** wheel to select "RM". Press it and "CAMERA MENU" appears.
- 4 Rotate the **MENU** wheel to select "SNAP MODE", then press it.
- 5 Rotate the **MENU** wheel to select the desired Snapshot mode, then press it. Rotate the **MENU** wheel to select "◀RETURN" and press it twice. The Menu Screen closes.

SNAPSHOT RECORDING

- 1 Press **SNAPSHOT**.
 - If you press during Record-Standby . . .*
 - "PHOTO" appears and a still image will be recorded for approx. 6 seconds, then the camcorder re-enters the Record-Standby mode.
 - If you press during Recording . . .*
 - "PHOTO" appears and a still image will be recorded for approx. 6 seconds, then the normal recording resumes.
 - To use the flash, ☞ pg. 32.

Motor Drive Mode

Keeping **SNAPSHOT** pressed provides an effect similar to serial photography. (Interval between still images: approx. 1 second)

NOTES:

- To remove the shutter sound, ☞ "BEEP/TALLY" on pg. 29.
- If Snapshot recording is not possible, "PHOTO" blinks when **SNAPSHOT** is pressed.
- If Program AE with special effects (☞ pg. 38) is engaged, certain modes of Program AE with special effects are disabled during Snapshot recording. In such a case, the icon blinks.
- If **SNAPSHOT** is pressed when "DIS" is set to "ON" (☞ pg. 30), the Stabilizer will be disabled.
- To dub images recorded on a tape to a MultiMediaCard, ☞ pg. 65.
- To reduce the Red-Eye effect in the subject's eyes when the flash fires, ☞ pg. 32.
- During playback as well, all snapshot modes are available when "COPY" is set to "OFF" in the Menu Screen (☞ pg. 43).
- When a headphone set is connected to the headphone connector, the shutter sound is not heard from the speaker, however it is recorded onto the tape.



FULL
Snapshot mode with
no frame*



PIN-UP
Pin-Up mode

* There is the sound effect of a shutter closing.

When the **MODE** Dial is set to "PS", snapshot recording will be performed with higher quality (☞ pg. 24).

Basic Shooting (Snapshot)

You can use your camcorder as a Digital Still Camera for taking snapshots.

NOTE:

You should already have performed the procedures listed below. If not, do so before continuing.

- Power (☞ pg. 8)
- Grip Adjustment (☞ pg. 10)
- Viewfinder Adjustment (☞ pg. 10)
- Loading A MultiMediaCard (☞ pg. 14)
- Picture Quality/Size Mode Setting (☞ pg. 15)

1 Set the **MODE Dial** to "**DSC**" and the **POWER Switch** to "**CAMERA**" while pressing down the **Lock Button** located on the switch. Open the LCD monitor fully or pull out the viewfinder fully.

2 Press **SNAPSHOT** halfway. The screen becomes a still image, which is captured into the camcorder's memory. However, it is not recorded until **SNAPSHOT** is pressed fully.

- At this moment, if you release **SNAPSHOT**, snapshot recording will be canceled.

3 Press **SNAPSHOT** fully. The image is recorded in the MultiMediaCard.

- Still images are recorded in the snapshot mode with no frame.
- To use the flash, ☞ pg. 32.

To Delete Unwanted Still Images . . .

..... when unwanted still images are stored in the MultiMediaCard or its memory is full, refer to "Deleting Files" (☞ pg. 51) and delete unwanted still images.

To Remove The Shutter Sound . . .

..... when you do not want to hear the shutter sound, set BEEP/TALLY to "OFF" on the Menu Screen (☞ pg. 28, 29). The sound is no longer heard from the speaker.

NOTES:

- Even if "DIS" is set to "ON" (☞ pg. 30), the Stabilizer will be disabled.
- If Snapshot recording is not possible, "PHOTO" blinks when **SNAPSHOT** is pressed.
- If Program AE with special effects (☞ pg. 38) is engaged, certain modes of Program AE with special effects are disabled during Snapshot recording. In such a case, the icon blinks.
- If shooting is not performed for approx. 5 minutes when the **POWER Switch** is set to "**CAMERA**" and power is supplied from the battery pack, the camcorder shuts off automatically to save power. To perform shooting again, close the LCD monitor and re-open it. When using the viewfinder, push back it in and pull it out again.
- The Motor Drive mode (☞ pg. 20) is disabled when the **MODE Dial** is set to "**DSC**".
- To reduce the Red-Eye effect in the subject's eyes when the flash fires, ☞ pg. 32.
- When a headphone set is connected to the headphone connector, the shutter sound is not heard from the speaker.
- Still images taken are compliant to DCF (Design rules for Camera File systems). They do not have any compatibility with devices which are not compliant to DCF.
- In the XGA mode, images shot using a 680,000-pixel Progressive Scan CCD (effective area: 630,000 pixels, 962 x 654 pixels) are converted and stored in the XGA mode file size (1024 x 768 pixels).

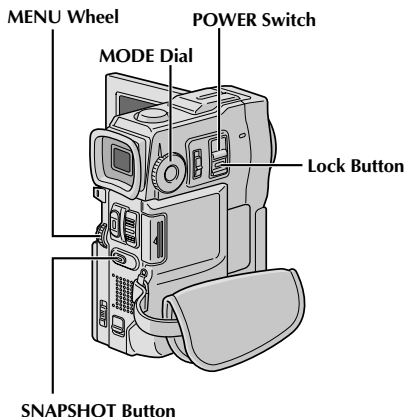

Total number of shots

Displays the approximate total number of shots that can be stored, including those already taken. The number increases or decreases depending on the shots stored, the Picture Quality/Size mode, **MODE Dial** setting, etc.

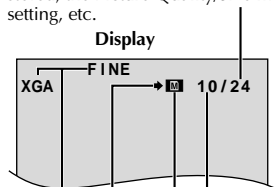

Number of shots taken
Displays the number of images that have already been shot.

Card icon
Appears during shooting and blinks when a MultiMediaCard is not loaded.

Shooting icon
Appears and blinks during shooting.

Picture Quality/Size mode

Displays the Picture Quality/Size mode of the stored image. There are 4 modes available: XGA FINE, XGA STD, VGA FINE, VGA STD (in order of quality) (☞ pg. 15).



FULL Snapshot mode with no frame

There is the sound effect of a shutter closing.

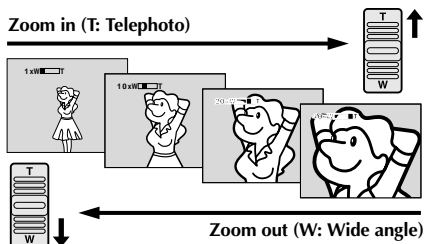

Zoom display

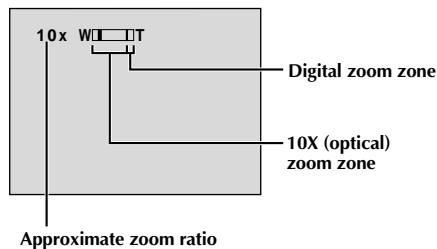

Power Zoom Lever

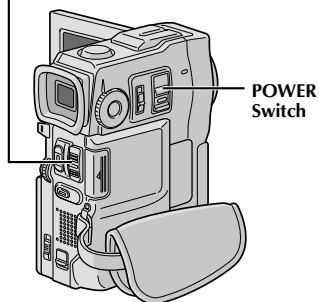
**FEATURE: Zooming****PURPOSE:**

To produce the zoom in/out effect, or an instantaneous change in image magnification.

OPERATION:**Zoom In**

Slide the Power Zoom Lever towards "T".

Zoom Out

Slide the Power Zoom Lever towards "W".

- The further you slide the Power Zoom Lever, the quicker the zoom action.

NOTES:

- Focusing may become unstable during Zooming. In this case, set the zoom while in Record-Standby, lock the focus by using the manual focus (☞ pg. 27), then zoom in or out in Record mode.
- Zooming is possible to a maximum of 200X, or it can be switched to 10X magnification using the optical zoom (☞ pg. 29).
- Zoom magnification of over 10X is done through Digital image processing, and is therefore called Digital Zoom.
- During Digital zoom, the quality of image may suffer.
- Digital zoom cannot be used in the following cases:
 - When digital image processing, such as Picture Wipe/Dissolve (☞ pg. 36, 37) or Video Echo (☞ pg. 38), is activated.
 - When the **MODE Dial** is set to "**DUAL**" or "**DSC**".
- Macro shooting (as close as approx. 5 cm (2") to the subject) is possible when the Power Zoom Lever is set all the way to "W". Also see "TELE MACRO" in the Menu Screen on page 30.

NOTE: Recording From The Middle Of A Tape

Time Code

During recording, a time code is recorded on the tape. This code is to confirm the location of the recorded scene on the tape during playback.

If recording starts from a blank portion, the time code begins counting from "00:00:00" (minute:second:frame). If recording starts from the end of a previously recorded scene, the time code continues from the last time code number.

To perform Random Assemble Editing (☞ pg. 70 – 75), time code is necessary. If during recording a blank portion is left partway through the tape, the time code is interrupted. When recording is resumed, the time code starts counting up again from "00:00:00". This means the camcorder may record the same time codes as those existing in a previously recorded scene. To prevent this, perform "Recording From The Middle of A Tape" below in the following cases;

- When shooting again after playing back a recorded tape.
- When power shuts off during shooting.
- When a tape is removed and re-inserted during shooting.
- When shooting using a partially recorded tape.
- When shooting on a blank portion located partway through the tape.
- When shooting again after shooting a scene then opening/closing the cassette holder cover.

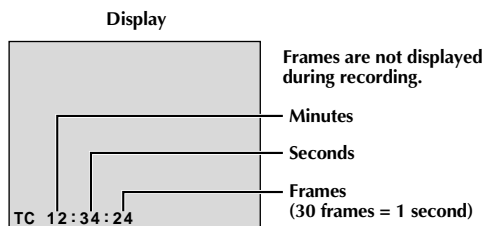

Recording From The Middle Of A Tape

1. Play back a tape or use Blank Search (☞ pg. 45) to find the spot at which you want to start recording, then engage the Still Playback mode (☞ pg. 42).
2. Set the **POWER** Switch to "**CAMERA**" while pressing down the Lock Button located on the switch, then start recording.

NOTES:

- The time code cannot be reset.
- During fast-forwarding and rewinding, the time code indication does not move smoothly.
- The time code is displayed only when "TIME CODE" is set to "ON" (☞ pg. 31, 43).

When a blank portion is recorded on a tape

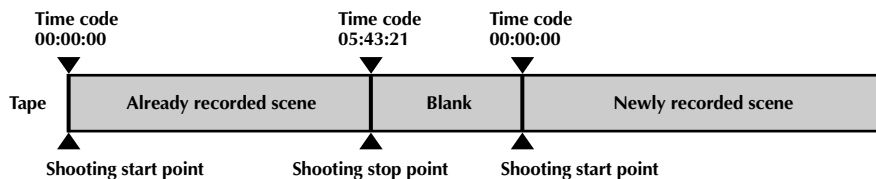

Proper recording

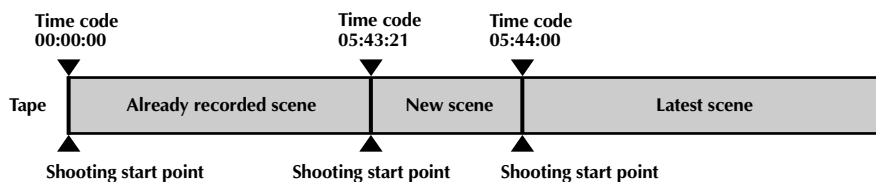

START/STOP Button

MODE Dial

POWER Switch

Lock Button

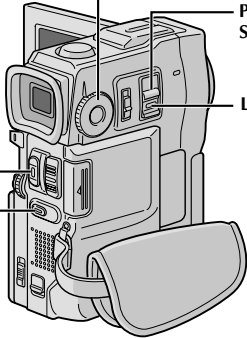

SNAPSHOT Button

Progressive Mode Recording

This mode lets you record moving images (successive jitter-free still images) onto a tape. Images can then played back jitter-free, with superior quality. High-resolution still images can also be processed on a personal computer or can be printed out (☞ pg. 61).

- 1** Set the **MODE Dial** to "**PS**", then set the **POWER Switch** to "**CAMERA**" while pressing down the **Lock Button** located on the switch. Pull out the viewfinder fully or open the LCD monitor fully.
- 2** To start Progressive Mode Recording, press **START/STOP**.

To End Progressive Mode Recording . . .

.... press **START/STOP**. The camcorder enters the Record-Standby mode.

NOTES:

- When an image recorded using the Progressive Mode is played back, the image may not look natural.
- When the **MODE Dial** is set to "**PS**", *Picture Wipe/Dissolve* (☞ pg. 36) and some *Program AE with special effects* (☞ pg. 38) cannot be used.
- If **SNAPSHOT** is pressed in the **PS** mode, a snapshot will be recorded with higher quality than in **VIDEO** mode. (☞ pg. 20).

Description of Progressive Scan CCD

Progressive Scan is a special image sensing method which, unlike conventional interlace scanning, is able to pick up all the lines of picture information in one Scan. Since the Progressive Scan CCD is capable of outputting 60 full Frames* per second — twice the amount of conventional systems — it is able to deliver a high quality picture even when its output signal is converted to a format that can be viewed on a TV screen.

*A NTSC TV screen image is composed of 30 Frames per second. 1 Frame is made up of 2 Fields.

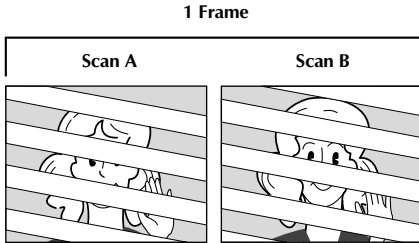

1. Regular shooting of moving images

Records 30 odd and 30 even image Fields, for a total of 60 per second. Since there is a time lag between an odd and even Field, when they are combined to make 1 Frame the part of the image that is moving appears as image jitter. **However, during normal playback, the moving picture looks smooth and natural.**

2. Progressive mode shooting of moving images (Progressive Mode Recording pg. 24)

Scan A is recorded, divided into an odd- and even-number Field, and then Scan B is skipped. Scans C and D are handled in the same way as Scans A and B, as illustrated below, thereby recording 30 Frames per second.

Since each recorded odd- and even-number Field originates from the same Scan there is no time lag between them, and so when they are combined into a Frame and **a still image is displayed on a TV or PC monitor the picture does not look jittery. However, when moving images are played back, the picture can look unnatural.**

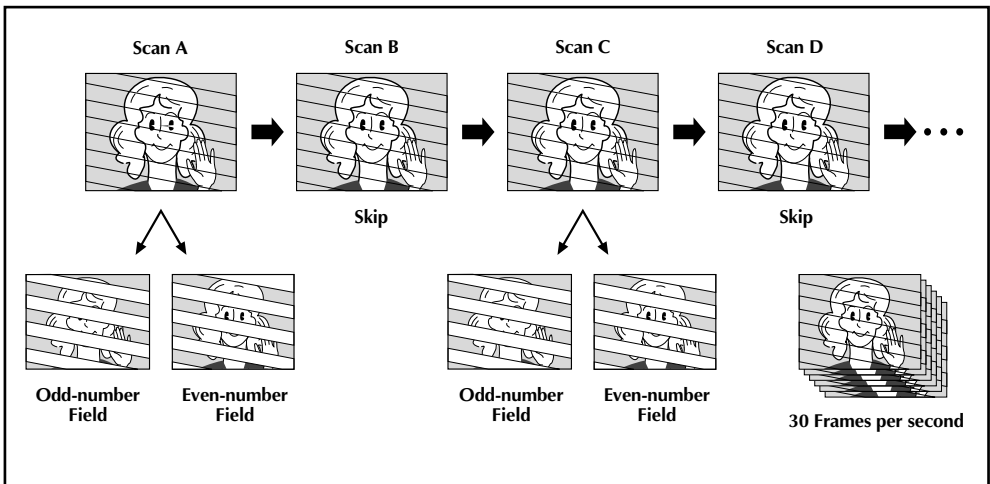

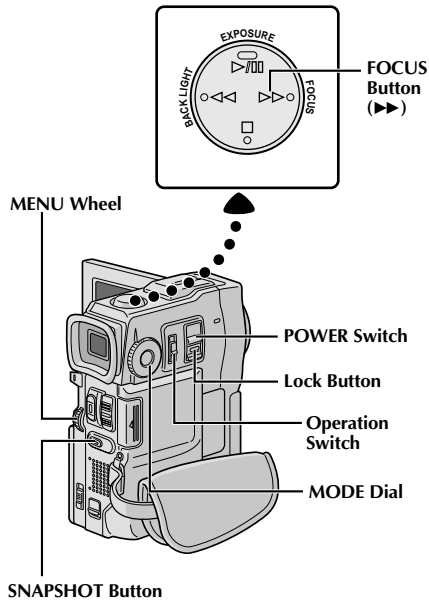

Dual Shooting

Lets you record images on a tape and store still images in a MultiMediaCard simultaneously. In other words, it is possible to store still images in the MultiMediaCard without interrupting image recording on the tape.

- 1** Set the **POWER** Switch to "**CAMERA**" while pressing down the Lock Button located on the switch and the **MODE** Dial to "**DUAL**". Pull out the viewfinder fully or open the LCD monitor fully.
- 2** While recording to a tape, press **SNAPSHOT** halfway. A still image is displayed in the lower right corner of the screen where the video image being recorded is displayed.
 - At this moment, if you release **SNAPSHOT**, snapshot recording will be canceled.
- 3** Press **SNAPSHOT** fully. The displayed still image is stored in the MultiMediaCard.

NOTES:

- If **SNAPSHOT** is pressed in the Record-Standby mode, only a still image is stored in the MultiMediaCard. Video recording does not take place.
- If **SNAPSHOT** is pressed when "DIS" is set to "ON" (☞ pg. 30), the Stabilizer will be disabled.
- The Stabilizer is less effective in the DUAL mode than in other modes.
- The flash is disabled during video recording.
- Still images are stored in the MultiMediaCard in VGA mode file size (☞ pg. 17).
- When the **MODE** Dial is set to "DUAL", all Fade/Wipe Effects and some Program AE with special effects cannot be used (☞ pg. 36 – 38).

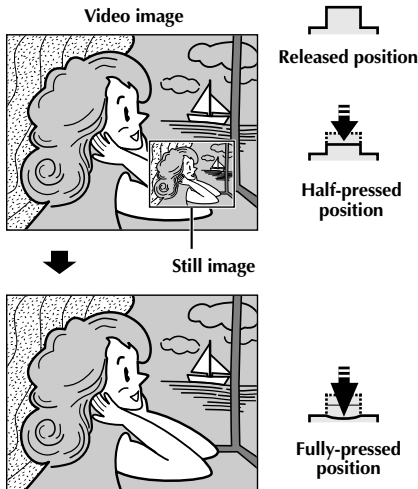

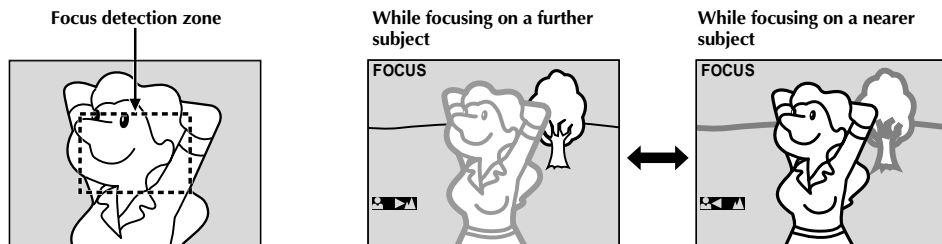

FEATURE: Auto Focus

PURPOSE:

The camcorder's Full Range AF system offers continuous shooting ability from close-up (as close as approx. 5 cm (2") to the subject) to infinity.

However, correct focus may not be obtainable in the situations listed below (in these cases use manual focusing):

- When two subjects overlap in the same scene.
- When illumination is low.*
- When the subject has no contrast (difference in brightness and darkness), such as a flat, one-color wall, or a clear, blue sky.*
- When a dark object is barely visible in the viewfinder.*
- When the scene contains minute patterns or identical patterns that are regularly repeated.
- When the scene is affected by sunbeams or light reflecting off the surface of a body of water.
- When shooting a scene with a high-contrast background.

* The following low-contrast warnings are blinking: ▲, ◀, ▶ and 👤

NOTES:

- If the lens is smeared or blurred, accurate focusing is not possible. Keep the lens clean, wiping with a piece of soft cloth if it gets dirty. When condensation occurs, wipe with a soft cloth or wait for it to dry naturally.
- When shooting a subject close to the lens, zoom out first (☞ pg. 22). If zoomed-in in the auto focus mode, the camcorder may automatically zoom out depending on the distance between the camcorder and the subject. This will not occur when "TELE MACRO" (☞ pg. 30) is activated.

FEATURE: Manual Focus

PURPOSE:

To obtain correct focus.

OPERATION:

- 1) If you are using the viewfinder, you should already have made the necessary viewfinder adjustments (☞ pg. 10).
- 2) Set the Operation Switch to "M" and set the POWER Switch to "CAMERA" while pressing down the Lock Button located on the switch, then press FOCUS (▶▶). The manual focus indicator appears.
- 3) To focus on a farther subject, rotate the MENU wheel towards "+". "▶" appears and blinks. To focus on a nearer subject, rotate the MENU wheel towards "-". "◀" appears and blinks.
- 4) Press the MENU wheel. Focus adjustment is complete.

To reset to Auto Focus, press FOCUS (▶▶) twice or set the Operation Switch to "A".

If FOCUS (▶▶) is pressed once, the camcorder will enter the focus adjustment mode again.

NOTES:

- Be sure to focus the lens in the maximum telephoto position when you use the Manual Focus mode. If you focus in on a subject in the wide-angle position, sharply focused images cannot be obtained when zoomed up because the depth-of-field is reduced at longer focal lengths.
- When the focus level cannot be adjusted any further or closer, "▲" or "👤" will blink.

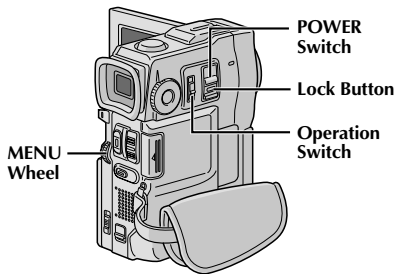



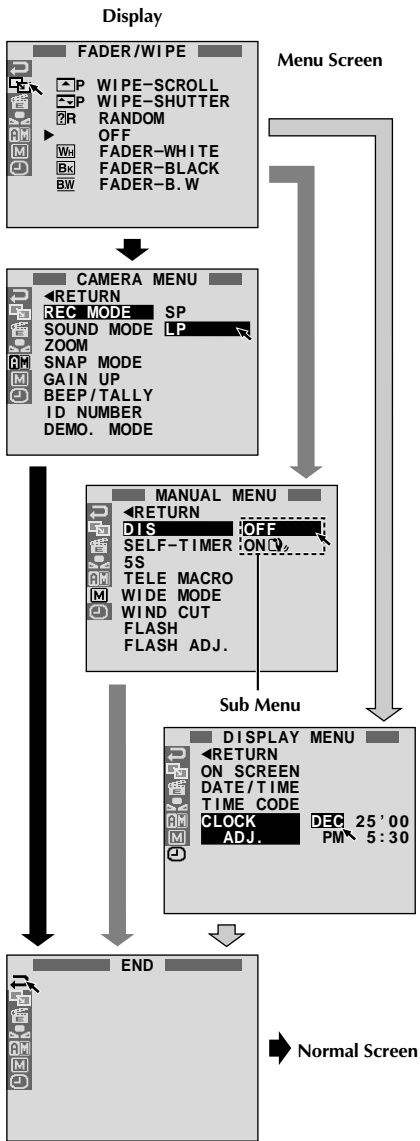

Using Menus For Detailed Adjustment

This camcorder is equipped with an easy-to-use, on-screen menu system that simplifies many of the more detailed camcorder settings (see pg. 29 – 31).

- 1** Set the Operation Switch to "M" and set the **POWER** Switch to "CAMERA" while pressing down the Lock Button located on the switch, then pull out the viewfinder fully or open the LCD monitor fully.
- 2** Press the **MENU** wheel. The Menu Screen appears.
- 3** Rotate the **MENU** wheel to select the desired function icon, and press it. The selected function menu appears.
- 4** Function menu setting depends on the function.
 - If you have selected "L", "E" or "S"...*
.... see pg. 29.
 - If you have selected "R", "M" or "C"...*
.... go to step 5.
- 5** Rotate the **MENU** wheel to select the desired function and press it. The Sub Menu appears. Then, rotate the **MENU** wheel to select the parameter, and press it. Selection is complete.
- 6** Rotate the **MENU** wheel to select "◀RETURN" and press it twice. The Menu Screen closes.
 - The  icon represents "END".



Menu Screen Explanations

	FADER/WIPE	Refer to “Fade/Wipe Effects” (☞ pg. 36, 37).	
	P.AE/EFFECT	Refer to “Program AE With Special Effects” (☞ pg. 38).	
	W.BALANCE	Refer to “White Balance Adjustment” and “Manual White Balance Operation” (☞ pg. 41).	
CAMERA MENU	REC MODE	Allows you to set the recording mode (SP or LP) depending on your preference (☞ pg. 13).	
	SOUND MODE	12 BIT	Enables video recording of stereo sound on four separate channels, and is recommended for use when performing audio dubbing. (Equivalent to the 32 kHz mode of previous models)
		16 BIT	Enables video recording of stereo sound on two separate channels. (Equivalent to the 48 kHz mode of previous models)
	ZOOM	10X	When set to “10X” while using digital zoom, the zoom magnification will reset to 10X since digital zoom will be disengaged.
		40X	Allows you to use the Digital Zoom. By digitally processing and magnifying images, zooming is possible from 10X (the optical zoom limit), to a maximum of 40X digital magnification.
		200X	Allows you to use the Digital Zoom. By digitally processing and magnifying images, zooming is possible from 10X (the optical zoom limit), to a maximum of 200X digital magnification.
	SNAP MODE	FULL	Refer to “Snapshot (For Video Recording)” (☞ pg. 20).
		PIN-UP	
	GAIN UP	OFF	Allows you to shoot dark scenes with no picture brightness adjustment.
		AGC	The overall appearance may be grainy, but the image is bright.
		AUTO 	The shutter speed is automatically adjusted (1/30 — 1/200 sec.). Shooting a subject in low or poor lighting at 1/30 sec. shutter speed provides a brighter image than in the AGC mode, but the subject’s movements are not smooth or natural. The overall appearance may be grainy. When shooting a subject in low lighting in this mode, “  ” is displayed.
	BEEP/TALLY	ON: MEL.	The tally lamp comes on to signal the start of recording. Instead of a beep, a melody sounds when any operation is performed. It also activates the shutter sound effect (☞ pg. 20, 21).
		ON:BEEP	The tally lamp comes on to signal the start of recording. The beep sounds when the power is turned on or off, and at the beginning and end of recording. Also to activate the shutter sound effect (☞ pg. 20, 21).
OFF		The tally lamp remains off at all times. Even though not heard while shooting, shutter sound is recorded on the tape.	
ID NUMBER	This number is necessary when connecting the camcorder to a device such as a computer using the J terminal (JLIP). The numbers range from 01 to 99. Factory setting is 06.		







 : Factory-preset





NOTE:

The “ CAMERA MENU” settings are effective when the Operation Switch is set to both “” and “”.

CONTINUED ON NEXT PAGE



Menu Screen Explanations (cont.)

CAMERA MENU	DEMO. MODE	ON	Demonstrates certain functions such as Program AE with special effects, etc., and can be used to confirm how these functions operate. When "DEMO. MODE" is set to "ON" and the Menu Screen is closed, demonstration starts. Performing any operation during the demonstration stops the demonstration temporarily. If no operation is performed for more than 1 minute after that, the demonstration will resume. NOTES: <ul style="list-style-type: none"> ● If a tape is in the camcorder, the demonstration cannot be turned on. ● "DEMO. MODE" remains "ON" even if the camcorder power is turned off. ● If "DEMO. MODE" remains "ON", some functions will not be available. After viewing demo, set to "OFF".
		OFF	Automatic demonstration will not take place.
MANUAL MENU	DIS	OFF	To compensate for unstable images caused by camera-shake, particularly at high magnification. NOTES: <ul style="list-style-type: none"> ● Accurate stabilization may not be possible if hand shake is excessive, or under the following conditions: <ul style="list-style-type: none"> ● When shooting subjects with vertical or horizontal stripes. ● When shooting dark or dim subjects. ● When shooting subjects with excessive backlighting. ● When shooting scenes with movement in various directions. ● When shooting scenes with low-contrast backgrounds. ● Switch off this mode when recording with the camcorder on a tripod. ● The "DIS" indicator blinks or goes out if the Stabilizer cannot be used.
		ON 	
	SELF-TIMER	Refer to "Self-Timer" ( pg. 34).	
	5S	OFF	Refer to "5-Second Recording" ( pg. 35).
		5S	
		ANIM.	Allows you to record a few frames only. By using an inanimate object and changing its position between shots, you can record the subject as though it is moving ( pg. 35).
	TELE MACRO	OFF	Usually the distance to a subject where the lens is in focus depends on the zoom magnification. Unless there is a distance more than 1m (3.3 ft.) to the subject, the lens is out of focus at the maximum telephoto setting. When set to "ON", you can shoot a subject as large as possible at a distance of approx. 60 cm (2 ft.). <ul style="list-style-type: none"> ● Depending on the zoom position, the lens may go out of focus.
ON			
WIDE MODE	OFF	Records with no change in the screen ratio. For playback on a TV with a normal screen ratio.	
	CINEMA	Inserts black bands at the top and bottom of the screen. During playback on wide-screen TVs, the black bands at the top and bottom of the screen are cut and the screen ratio becomes 16:9.  appears. When using this mode, refer to your wide-screen TV's instruction manual. During playback/recording on 4:3 TVs/LCD monitor/viewfinder, black bands are inserted at the top and bottom of the screen and the image appears like a letterboxed 16:9 movie. <ul style="list-style-type: none"> ● "CINEMA" mode is effective only when the MODE Dial is set to "VIDEO" or "PS". 	
	SQUEEZE	For playback on TVs with an aspect ratio of 16:9. Naturally expands the image to fit the screen without distortion.  appears. When using this mode, refer to your wide-screen TV's instruction manual. During playback/recording on 4:3 TVs/LCD monitor/viewfinder, the image is elongated vertically. <ul style="list-style-type: none"> ● "SQUEEZE" mode is effective only when the MODE Dial is set to "VIDEO" or "PS". 	
	PS-WIDE	"  " appears. The zoom range is extended beyond the maximum optical zoom wide angle range. This mode's wide angle setting is equivalent to using a 0.7X wide conversion lens. Zooming is possible from 0.7X to 10X. This mode is suitable for shooting in a small room. <ul style="list-style-type: none"> ● "PS-WIDE" mode is effective only when the MODE Dial is set to "PS". 	

MANUAL MENU	WIND CUT	OFF	Disengages the function which cuts down on noise created by wind.
		ON 	Helps cut down on noise created by wind. "  " appears. The quality of the sound will change. This is normal.
	FLASH	Refer to "Snapshot Flash" ( pg. 32).	
DISPLAY MENU	FLASH ADJ.	Refer to "Flash Brightness Adjustment" ( pg. 33).	
	ON SCREEN	LCD	Keeps the camcorder's display (except the date, time and time code) from appearing on the connected TV screen.
LCD/TV		Makes the camcorder's display appear on screen when the camcorder is connected to a TV.	
SIMPLE		Keeps the indications (except the tape running indicator, warnings, date, time, time code, etc.) from appearing in the camcorder. Also keeps the camcorder's display (except the date, time and time code) from appearing on the connected TV screen.	
DATE/TIME	AUTO	Displays the date/time for approx. 5 seconds in the following cases:	
		<ul style="list-style-type: none"> • When the POWER Switch is set from "OFF" to "CAMERA" or "PLAY/PC". • When playback starts. The camcorder displays the date/time when scenes are recorded. • When the date is changed during playback. 	
		OFF	
TIME CODE	ON	The date/time is always displayed.	
	OFF	Time code is not displayed.	
CLOCK ADJ.	ON	Time code is displayed on the camcorder and on the connected TV. Frame numbers are not displayed during recording.	
	Allows you to set the current date and time ( pg. 11).		

 : Factory-preset

NOTES:

- The "MANUAL MENU" settings are effective only when the Operation Switch is set to "**M**".
- "DISPLAY MENU" functions which are set when the **POWER** Switch is set to "**CAMERA**" are also applied when the **POWER** Switch is set to "**PLAY/PC**" ( pg. 43). "CLOCK ADJ." only appears when the **POWER** Switch is set to "**CAMERA**".
- The "DISPLAY MENU" settings are effective even when the Operation Switch is set to "**A**".
- The "ON SCREEN" setting can also be changed by pressing the **DISPLAY** Button on the remote control (provided) ( pg. 59, 62, 71).

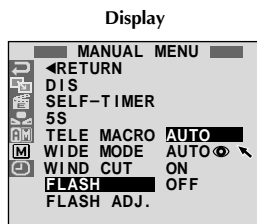
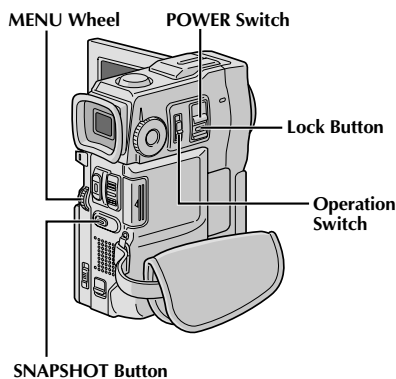

Snapshot Flash

The flash can be used when a snapshot is taken in Record-Standby (☞ pg. 20, 21).

- In Full Auto mode, the flash automatically fires if it is dark (⚡ appears).
- In Manual mode, you can select the "FLASH" setting as follows:

AUTO : Fires automatically if it is dark (⚡ appears).
 AUTO (👁) : Fires automatically if it is dark (⚡ appears) and reduces the Red-Eye effect in the subject's eyes.

ON : Always fires.

OFF : Will not fire.

Perform the procedure below.

- 1 Set the Operation Switch to "M" and set the **POWER** Switch to "CAMERA" while pressing down the Lock Button located on the switch, then pull out the viewfinder or open the LCD monitor fully.
- 2 Press the **MENU** wheel. The Menu Screen appears.
- 3 Rotate the **MENU** wheel to select "M", and press it. "MANUAL MENU" appears.
- 4 Rotate the **MENU** wheel to select "FLASH", and press it. The Sub Menu appears.
- 5 Rotate the **MENU** wheel to select "AUTO", "AUTO (👁)", "ON" or "OFF", and press it. Rotate the **MENU** wheel to select "RETURN". Press it twice to close the Menu Screen.

If "AUTO (👁)" Is Selected . . .

.... the 👁 Red-Eye reduction indicator lights. Press **SNAPSHOT**. The flash fires twice. The first flash is for reduction of the human eye's red reflection and the second flash is for the actual recording.

NOTES:

- Do not fire the flash at a person at short range.
- The flash does not fire when the flash is set to "OFF" in the Menu Screen, and also when the battery remaining power is low. Moreover, the flash does not fire when it is set to "AUTO" in the Menu Screen with GAIN UP set to "OFF" (☞ pg. 29) and with Programme AE with special effects set to "TWILIGHT" (☞ pg. 38).
- When taking several snapshots in succession (Motor Drive Mode), the flash fires only during the first one.
- Although images shot with a flash tend to look whiter than they actually are, to compensate for this the camcorder automatically darkens the picture when using the flash. When shooting a subject at a distance where the flash light cannot reach (over approx. 6.5 ft./2 m), push down the flash to prevent the picture from becoming too dark or becoming too tinted.
- The color tone changes depending on the background lighting conditions, such as under fluorescent or halogen lamps.
- To change the brightness of the flash, ☞ "Flash Brightness Adjustment" (☞ pg. 33).
- While charging the flash, ⚡ blinks and the flash will not fire. Although noise may appear, this is not a malfunction and is not recorded. It can take up to 10 seconds to charge the flash.

Flash Brightness Adjustment

When a snapshot (☞ pg. 20, 21) is taken in the dark the camcorder fires the flash (☞ pg. 32) and adjusts the brightness automatically. You can also adjust the flash brightness manually. When you find that the snapshots you took look too bright or too dark, adjust it manually.

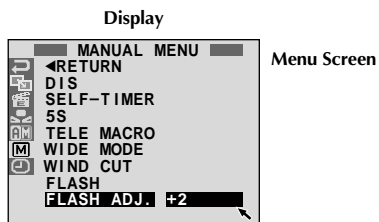
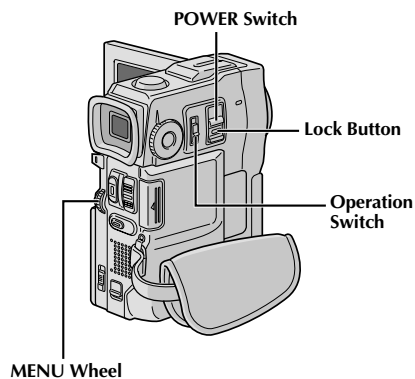

- 1** Set the Operation Switch to "M" and set the **POWER** Switch to "CAMERA" while pressing down the Lock Button located on the switch, then pull out the viewfinder or open the LCD monitor fully.
- 2** Press the **MENU** wheel. The Menu Screen appears.
- 3** Rotate the **MENU** wheel to select "M", and press it. "MANUAL MENU" appears.
- 4** Rotate the **MENU** wheel to select "FLASH ADJ.", and press it. The parameter appears.
- 5** To intensify the flash, rotate the **MENU** wheel towards "+". To weaken the flash, rotate it towards "-". Adjustment range: -3 to +3.
- 6** Press the **MENU** wheel. Rotate it to select "RETURN" and press it twice to close the Menu Screen.

NOTE:

When you change the subject you are shooting or the shooting location, set it back to ± 0 as described in step 5 and take a snapshot to check the flash brightness. After doing this adjust to your desired brightness.

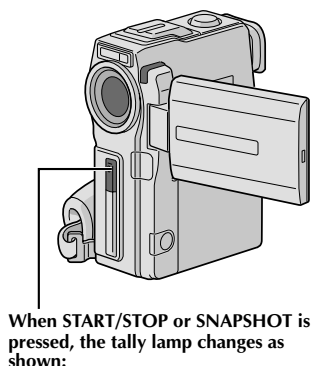
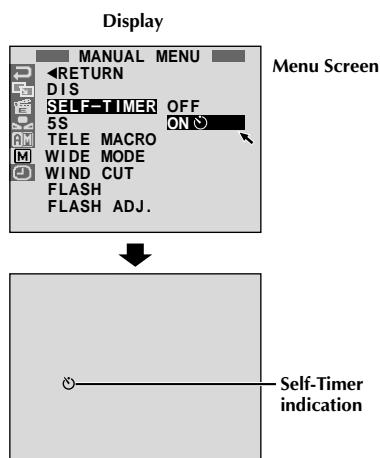
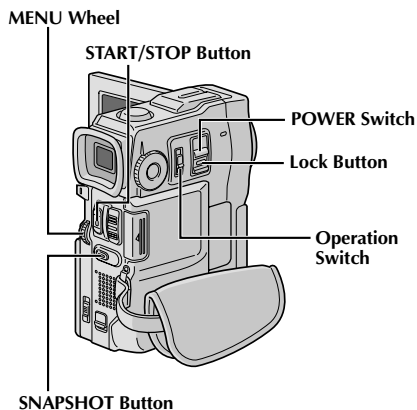

Self-Timer

Once the camcorder is set, the camcorder operator can become part of the scene in a more natural way, adding the final touch to a memorable picture.

- 1 Set the Operation Switch to "M" and set the **POWER** Switch to "CAMERA" while pressing down the Lock Button located on the switch, then pull out the viewfinder or open the LCD monitor fully.
 - You can tilt the LCD monitor upward to 180° so that it faces forward and view yourself while self-recording with the viewfinder pushed back.
- 2 Press the **MENU** wheel. The Menu Screen appears.
- 3 Rotate the **MENU** wheel to select "M", and press it.
- 4 Rotate the **MENU** wheel to select "SELF-TIMER", and press it. The Sub Menu appears. Rotate the **MENU** wheel to select "ON", and press it. Selection is complete. Rotate the **MENU** wheel to select "◀RETURN", and press it twice to close the Menu Screen.
- 5 To engage the Self-Timer for video recording, press **START/STOP**. After 15 seconds, the beep sounds and video recording starts. To stop Self-Timer recording, press **START/STOP** again. The camcorder re-enters Record-Standby mode.

OR

Press **SNAPSHOT**. After 15 seconds, the beep sounds and snapshot recording starts. After that, the camcorder re-enters Record-Standby mode.
- 6 To end Self-Timer recording, select "OFF" in step 4 or set the **POWER** Switch to "OFF" or set the Operation Switch to "A".

NOTE:

If "BEEP/TALLY" is set to "OFF" (☞ pg. 29), the beep does not sound and the tally lamp does not light.

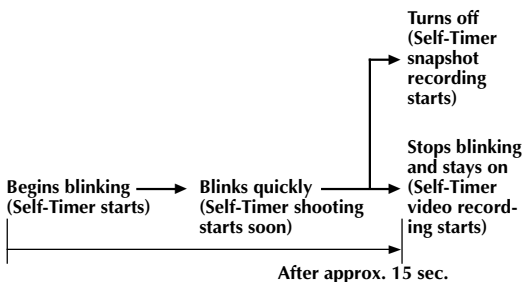

MENU Wheel

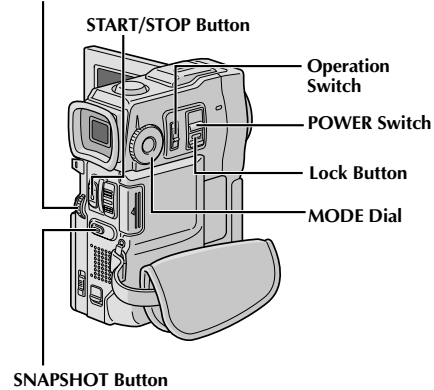

Display

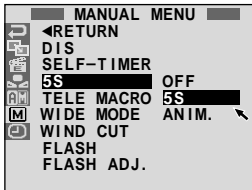

Menu Screen

5-Second Recording

Record a vacation or an important event in 5-second clips to keep the action moving. This function is available only for video recording.

- 1** Set the **POWER** Switch to "**CAMERA**" while pressing down the **Lock Button** located on the switch and set the **MODE Dial** to "**VIDEO**", "**PS**" or "**DUAL**", then set the **Operation Switch** to "**M**". Pull out the viewfinder fully or open the LCD monitor fully.
- 2** Press the **MENU** wheel. The Menu Screen appears.
- 3** Rotate the **MENU** wheel to select "**M**", and press it. "MANUAL MENU" appears.
- 4** Rotate the **MENU** wheel to select "5S", and press it. The Sub Menu appears.
- 5** Rotate the **MENU** wheel to select "5S", and press it.
 - "5S MODE" appears.
- 6** Press **START/STOP**. The tally lamp lights and beep sounds to indicate the start of recording, and after 5 seconds the camcorder enters Record-Standby mode.
 - Even if you press **START/STOP** again within 5 seconds after recording starts, Record-Standby mode is not engaged.
- 7** To exit the 5S mode, select "OFF" in step 5.

To Take A Snapshot In The 5-Second Recording Mode . . .

.... instead of pressing **START/STOP** in step 6, select the desired Snapshot mode in the Menu Screen, then press **SNAPSHOT**. The camcorder records a 5-second still (ⓘ pg. 20). When "5S" is set to "ANIM." (ⓘ pg. 30) this function is not available.

NOTE:

When "5S" is set to "ANIM." in the Menu Screen the 5-second recording mode is not available. Animation recording of a few frames only is taken instead (ⓘ pg. 30).

Fade/Wipe Effects

These effects let you make pro-style scene transitions. Use them to spice up the transition from one scene to the next. You can also vary transitions from scene to scene.

IMPORTANT:

Some Fade/Wipe Effects cannot be used with certain modes of Program AE with special effects (pg. 38). If an unusable Fade/Wipe Effect is selected, its indicator blinks or goes out.

START/STOP Button

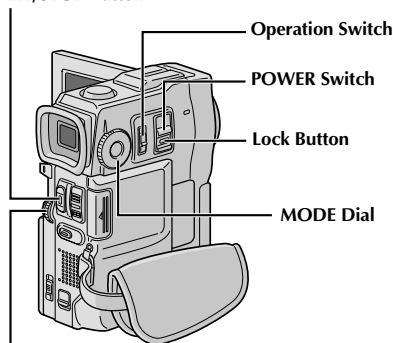

MENU Wheel

To Deactivate The Selected Effect . . .

.... select "OFF" in step 4.

NOTES:

- You can extend the length of a Fade or Wipe by pressing and holding **START/STOP**.
- If the power is turned off after a scene is finished recording, the stored point is erased, disabling the Picture Wipe/Dissolve combination. When this happens, the Picture Wipe/Dissolve indicator blinks. Also note that power shuts off automatically if 5 minutes elapse in the Record-Standby mode.
- Picture Wipe/Dissolve cannot be used when the **MODE Dial** is set to "**PS**".
- All Fade/Wipe Effects cannot be used when the **MODE Dial** is set to "**DUAL**".
- The sound at the end of the last recorded scene is not stored.

FADE/WIPE SELECTION (**W**, **Bk**, **BW**, **L**, **□**, **◀**, **▶**, **▲**, **▼** and **R**)

Fade or Wipe works when video recording is started or when you stop recording.

- 1 Set the **POWER Switch** to "**CAMERA**" while pressing down the **Lock Button** located on the switch and the **MODE Dial** to "VIDEO" or "**PS**", then set the **Operation Switch** to "**W**". Pull out the viewfinder fully or open the LCD monitor fully.
- 2 Press the **MENU wheel**. The Menu Screen appears.
- 3 Rotate the **MENU wheel** to select "**W**", then press it.
- 4 Rotate the **MENU wheel** to select the desired function, then press it. Selection is complete.
 - The **FADER/WIPE** Menu disappears and the effect is reserved. The indicator representing the selected effect appears.
- 5 Press **START/STOP** to activate the Fade-in/out or Wipe-in/out.

PICTURE WIPE OR DISSOLVE SELECTION (**WP**, **LP**, **OP**, **KP**, **KP**, **AP** and **VP**)

The Picture Wipe or Dissolve works when video recording is started.

- 1 Follow steps 1 through 4 above.
- 2 Engage the Record-Standby mode.

If you select Picture Wipe/Dissolve during recording . . .

.... press **START/STOP** when one scene is finished. The point at which the scene ended is stored in memory.























If you select Picture Wipe/Dissolve during Record-Standby mode . . .

.... press **START/STOP** to start recording and press it again when one scene is finished. The point at which the scene ended is stored in memory.

If you select Picture Wipe/Dissolve during Record-Standby mode after performing a Picture Wipe/Dissolve . . .

.... the point at which the scene ended is already stored in memory.
- 3 If you start recording a new scene within 5 minutes of the end of the previous recording (without having turned the camcorder's power off), the previous scene wipes out, revealing the new scene.

Fader And Wipe Menu

Menu	Effect
 FADER — WHITE	Fade in or out with a white screen.
 FADER — BLACK	Fade in or out with a black screen.
 FADER — B.W	Fade in to a color screen from a black and white screen, or fade out from color to black and white.
 WIPE — CORNER	Wipe in on a black screen from the upper right to the lower left corner, or wipe out from lower left to upper right, leaving a black screen.
 WIPE — WINDOW	The scene starts in the center of a black screen and wipes in toward the corners, or comes in from the corners, gradually wiping out to the center.
 WIPE — SLIDE	Wipe in from right to left, or wipe out from left to right.
 WIPE — DOOR	Wipe in as the two halves of a black screen open to the left and right, revealing the scene, or wipe out and the black screen reappears from left and right to cover the scene.
 WIPE — SCROLL	The scene wipes in from the bottom to the top of a black screen, or wipes out from top to bottom, leaving a black screen.
 WIPE — SHUTTER	Wipe in from the center of a black screen toward the top and bottom, or wipe out from the top and bottom toward the center leaving a black screen.
 P DISSOLVE	The new scene gradually appears as the old one gradually disappears.
 P WIPE — CORNER	The new scene wipes in over the previous one from the upper right corner to the lower left corner.
 P WIPE — WINDOW	The next scene gradually wipes in from the center of the screen toward the corners, covering the previous scene.
 P WIPE — SLIDE	The next scene gradually wipes in over the previous one from right to left.
 P WIPE — DOOR	The previous scene wipes out from the center to the right and left, like a door being pushed open to reveal the next scene.
 P WIPE — SCROLL	The new scene wipes in over the last one from the bottom of the screen to the top.
 P WIPE — SHUTTER	The new scene wipes in over the previous one from the center toward the top and bottom of the screen.
 R RANDOM	When this function is activated, the camcorder randomly selects the effect used in scene transition (from BW , WH , BK ,  ,  ,  ,  , and ). The Picture Wipe/Dissolve function is not available.

IMPORTANT:

Some modes of Program AE with special effects cannot be used with certain Fade/Wipe Effects (☞ pg. 37). If an unusable mode is selected, its indicator blinks or goes out.

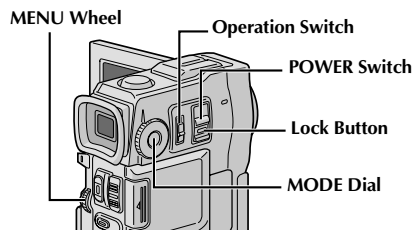

Display

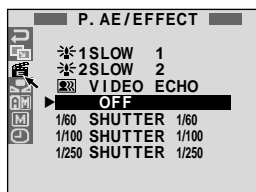

Menu Screen

Program AE With Special Effects

- 1** Set the Operation Switch to "M", then set the **POWER** Switch to "CAMERA" while pressing down the Lock Button located on the switch. Pull out the viewfinder fully or open the LCD monitor fully.
- 2** Press the **MENU** wheel. The Menu Screen appears.
- 3** Rotate the **MENU** wheel to select "☑", then press it.
- 4** Rotate the **MENU** wheel to select the desired mode, then press it. Selection is complete.
 - The P.AE/EFFECT Menu disappears and the selected mode is activated. The selected mode indicator appears.

To Deactivate The Selected Mode . . .

.... select "OFF" in step 4.

NOTE:

Program AE with special effects can be changed during recording or during Record-Standby.

☾ TWILIGHT

Makes evening scenes look more natural. White Balance (☞ pg. 41) is initially set to ☀, but can be changed to your desired setting. When Twilight is chosen, the camcorder automatically adjusts the focus from approx. 10 m (32 ft) to infinity. From less than 10 m (32 ft), adjust the focus manually. The flash does not fire in this mode.

🖼️ SEPIA*1

Recorded scenes have a brownish tint like old photos. Combine this with the Cinema mode for a classic look.

B/W MONOTONE*1

Like classic black and white films, your footage is shot in B/W. Used together with the Cinema mode, it enhances the "classic film" effect.

🌟 CLASSIC FILM*2

Gives recorded scenes a strobe effect.

📄 STROBE*2

Your recording looks like a series of consecutive snapshots.

👁️ VIDEO ECHO*3

Adds a "ghost" to the subject, giving your recording a "fantasy" feeling. Zoom magnification of over 10X is not available.

SLOW (Slow Shutter)*4

Lights dark subjects or areas even brighter than they would be under good natural lighting. Use "SLOW" only in dark areas.

☞ 1 SLOW 1

Slow Shutter raises light sensitivity to allow shooting in dark environments.

☞ 2 SLOW 2

Slow Shutter raises light sensitivity further to allow shooting in even darker environments.

NOTES:

- When using "SLOW", the image takes on a strobe-like effect.
- If the manual focus indicator blinks when "SLOW" is used, adjust focus manually and use a tripod.

SHUTTER (Variable Shutter Speed)

1/60—The shutter speed is fixed at 1/60th of a second. Black bands that usually appear when shooting a TV screen become narrower.

1/100—The shutter speed is fixed at 1/100th of a second. The flickering that occurs when shooting under a fluorescent light or mercury-vapor lamp is reduced.

1/250—This setting allows fast-moving images to be captured one frame at a time, for vivid, stable slow-motion playback. The faster the shutter speed, the darker the picture becomes. Use the shutter function under good lighting conditions.

*1 Not available when the **MODE** Dial is set to "DUAL".

*2 Available only when the **MODE** Dial is set to "VIDEO" or "PS".

*3 Available only when the **MODE** Dial is set to "VIDEO" or "DSC" (VGA STD/VGA FINE only).

*4 Available only when the **MODE** Dial is set to "VIDEO", "PS" or "DSC".

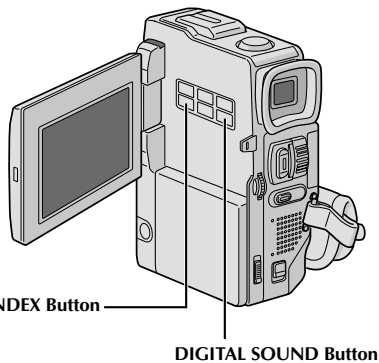

Display

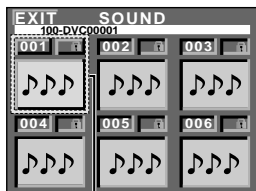

Selected (framed in green)

You can download sound data available at our Web Site (see below for URL) and transfer them from your PC to the MultiMediaCard to create more sound effects.

<http://www.jvc-victor.co.jp/english/download/d-sound/index.html>

- Use the PC card adapter CU-V50U or floppy adapter CU-VFM40U to transfer sound data from a PC to the MultiMediaCard.
- Sound data should be copied into the MultiMediaCard's DCSD¥100JVCGR folder.
- The file names should be in numerical sequence starting from DVC0001.mp3. If you are using the provided MultiMediaCard, file names should be from DVC0013.mp3 since 12 sound effects are pre-stored as DVC0001.mp3 through DVC0012.mp3.

Digital Sound Effects

12 sound effects (EXPLOSION, SIREN, LAUGHTER, RACE CAR, DOOR BELL, BUZZER, FANFARE, APPLAUSE, CHEERS, BOING, SCREAM and JEERS) pre-stored in the provided MultiMediaCard can be dubbed onto a tape.

SOUND EFFECT MODE SELECTION

- 1 Load the provided MultiMediaCard (☞ pg. 14) and a cassette (☞ pg. 12).
- 2 Set the **POWER** Switch to "**CAMERA**" while pressing down the Lock Button located on the switch and set the **MODE** Dial to "**PS**", "**VIDEO**" or "**DUAL**". Open the LCD monitor fully or pull out the viewfinder fully.
- 3 Press **INDEX**. The **SOUND** Index Screen appears.
- 4 Rotate the **MENU** wheel to select the desired sound effect.
 - Pressing **DIGITAL SOUND** starts playback of the currently selected sound effect so you can check it without recording it onto the tape. Press **DIGITAL SOUND** again to stop the sound effect playback.
- 5 Press the **MENU** wheel. The selection is complete.

SOUND EFFECT RECORDING

- 6 Press **DIGITAL SOUND** during recording. The selected sound effect indication with a "♪" mark appears blinking and the sound effect is recorded onto the tape.
 - The sound effect cannot be heard from the speaker during recording. Use a headphone set to hear the sound effect.

To cancel recording the sound effect midway . . .

.... press **DIGITAL SOUND** again. The camcorder stops recording the sound effect and the sound effect indication disappears.

NOTES:

- Sound effects can also be used for Audio Dubbing (☞ pg. 77).
- Sound effects created on a PC can be transferred to a MultiMediaCard by copying them into the MultiMediaCard's sound folder with the specified file name. For details, refer to the instruction manual of the provided software.

Exposure Control

Manual exposure adjustment is recommended in the following situations:

- When shooting using reverse lighting or when the background is too bright.
- When shooting on a reflective natural background such as at the beach or when skiing.
- When the background is overly dark or the subject light.

- 1 Set the Operation Switch to "**M**" and set the **POWER** Switch to "**CAMERA**" while pressing down the Lock Button located on the switch, then pull out the viewfinder fully or open the LCD monitor fully.
- 2 Press **EXPOSURE**. "EXP." and the exposure control indicator appear.
- 3 Rotate the **MENU** wheel towards "+" to brighten the image, or towards "-" to darken the image. (maximum ± 6)
- 4 Press the **MENU** wheel. Exposure adjustment is complete. "EXP." goes out.

To Return To Automatic Exposure Control . . .

.... press **EXPOSURE** or set the Operation Switch to "**A**".

To Brighten The Subject Quickly . . .

.... press **BACKLIGHT**. **B** is displayed and the subject is brightened. If pressed again, **B** disappears and the brightness returns to the previous level.

- +3 exposure has the same effect as the **BACKLIGHT** Button.
- Using **BACKLIGHT** may cause the light around the subject to become too bright and the subject to become white.
- Backlight compensations is also available when the Operation Switch is set to "**A**".

Iris Lock

Use this function in the following situations:

- When shooting a moving subject.
- When the distance to the subject changes (so its size in the LCD monitor or the viewfinder changes), such as when the subject is backing away.
- When shooting on a reflective natural background such as at the beach or when skiing.
- When shooting objects under a spotlight.
- When zooming.

When the subject is close, keep the iris locked. Even when the subject moves away from you, the image will not darken or brighten.

Before the following steps, perform steps 1 and 2 of "Exposure Control".

- 3 Adjust zoom so that the subject fills the LCD monitor or the viewfinder, then press and hold the **MENU** wheel for over 2 seconds. The exposure control indicator and "**L**" appear. Press the **MENU** wheel. "**L**" changes to "**L**" and the iris is locked. "EXP." goes out.

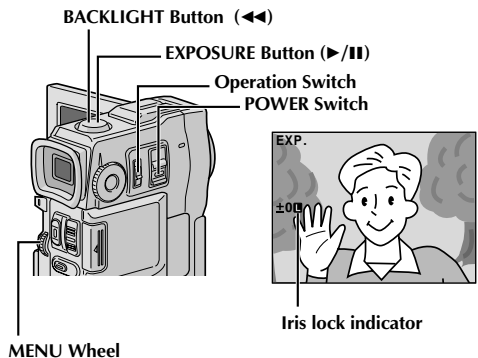

To Return To Automatic Iris Control . . .

.... press **EXPOSURE** so that the exposure control indicator and "**L**" disappear. Or, set the Operation Switch to "**A**".

To Lock The Exposure Control And The Iris . . .

.... after step 2, adjust the exposure rotating the **MENU** wheel. Then lock the iris in step 3. For automatic locking, press **EXPOSURE** again in step 2. The iris becomes automatic after about 2 seconds.

Iris

Like the pupil of the human eye, it contracts in well-lit environments to keep too much light from entering, and dilates in dim environments to allow in more light.

White Balance Adjustment

A term that refers to the correctness of color reproduction under various lighting. If the white balance is correct, all other colors will be accurately reproduced.

The white balance is usually adjusted automatically. However, more advanced camcorder operators control this function manually to achieve a more professional color/tint reproduction.

- 1** Set the Operation Switch to "M" and set the **POWER** Switch to "CAMERA" while pressing down the Lock Button located on the switch, then pull out the viewfinder fully or open the LCD monitor fully.
- 2** Press the **MENU** wheel. The Menu Screen appears.
- 3** Rotate the **MENU** wheel to select "WB", then press it. The "W.BALANCE" Menu appears.
- 4** Rotate the **MENU** wheel to select "MANUAL", and press it. The Menu Screen disappears and "W.BAL" and the currently selected mode are displayed. Rotate it to select the desired mode.
 - "MAN." – White balance is set manually.
 - "☀" – Outdoors on a sunny day.
 - "☁" – Outdoors on a cloudy day.
 - "💡" – A video light or similar type of lighting is used.
- 5** Press the **MENU** wheel. Selection is complete.

To Return To Automatic White Balance . . .

.... select "AUTO" in step 4. Or, set the Operation Switch to "A".

NOTE:

White balance cannot be used when Sepia or Monotone (☞ pg. 38) is activated.

Manual White Balance Operation

Perform Manual White Balance when shooting under various types of lighting.

- 1** Follow steps 1 through 4 of the white balance adjustment, and select "MAN.".
- 2** Hold a sheet of plain white paper in front of the subject. Adjust zoom or position yourself so that the white paper fills the screen.
- 3** Press the **MENU** wheel until ☑ begins blinking. When the setting is completed, ☑ stops blinking.
- 4** Press the **MENU** wheel. Only the Manual White Balance indicator ☑ is displayed.

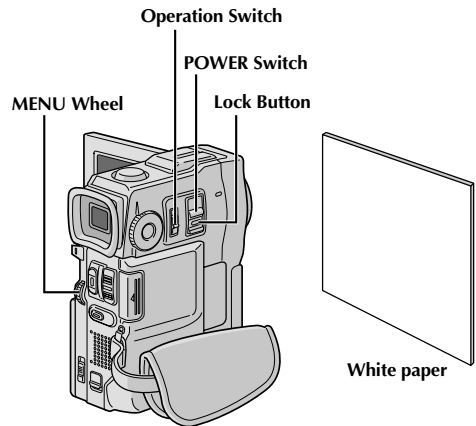

To Change The Tint For Recording . . .

.... in step 2, substitute colored paper for white. The white balance is adjusted based on the color, changing the tint. Red paper = deeper green; blue paper = orange; yellow paper = deeper purple.

NOTES:

- In step 2, it may be difficult to focus on the white paper. In such a case, adjust focus manually (☞ pg. 27).
- A subject can be shot under various types of lighting conditions indoors (natural, fluorescent, candlelight, etc.). Because the color temperature is different depending on the light source, the subject tint will differ depending on the white balance settings. Use this function for a more natural result.
- Once you adjust white balance manually, the setting is retained even if the power is turned off or the battery removed.

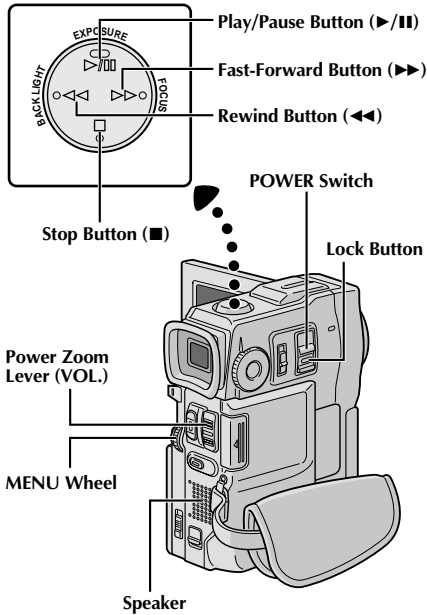

1 Load a tape (☞ pg. 12).

2 Set the **POWER** Switch to "**PLAY/PC**" while pressing down the Lock Button located on the switch. To start playback, press ▶/⏸.

- To stop playback, press ■.
- Press ◀◀ to rewind, or ▶▶ to fast-forward the tape during Stop mode.

To Control The Speaker Volume . . .

.... slide the Power Zoom Lever (**VOL.**) towards "+" to turn up the volume, or towards "-" to turn down the volume.

NOTES:

- If Stop mode continues for 5 minutes when power is supplied from a battery, the camcorder shuts off automatically. To turn on again, set the **POWER** Switch to "OFF", then to "**PLAY/PC**".
- The playback picture can be viewed in the LCD monitor, viewfinder or on a connected TV (☞ pg. 58).
- You can also view the playback picture on the LCD monitor with it flipped over and pushed against the camera body.
- LCD monitor/viewfinder indications:
 - When power is supplied from a battery: the "☐" battery pack remaining power indicator is displayed. When power is supplied through the DC cord: "☐" does not appear.
 - During Stop mode, none of the indications are displayed.
- When a cable is connected to the AV OUT connector, the sound is not heard from the speaker.

Still Playback: Pauses during playback.

- 1) Press ▶/⏸ during playback.
 - 2) To resume normal playback, press ▶/⏸ again.
- If still playback continues for more than about 3 minutes, the camcorder's Stop mode is automatically engaged. After 5 minutes in the Stop mode, the camcorder's power is automatically turned off.
 - When ▶/⏸ is pressed, the image may not pause immediately while the camcorder stabilizes the still image.

Shuttle Search: Allows high-speed search in either direction.

- 1) Press ▶▶ for forward or ◀◀ for reverse search during playback.
 - 2) To resume normal playback, press ▶/⏸.
- During playback, press and hold ◀◀ or ▶▶. The search continues as long as you hold the button. Once you release it, normal playback resumes.
 - A slight mosaic effect appears on screen during Shuttle Search. This is not a malfunction.

Frame-By-Frame Playback: Allows frame-by-frame search.

- 1) Engage Still Playback.
 - 2) Rotate the **MENU** wheel towards "+" for forward Frame-By-Frame Playback, or towards "-" for reverse Frame-By-Frame Playback during Still Playback.
- To resume normal playback, press ▶/⏸.
 - You can also use the provided remote control for Frame-By-Frame Playback (☞ pg. 68).

Slow-Motion Playback, Playback Zoom and Playback Special Effects

Available only with the remote control (provided) (☞ pg. 68, 69).

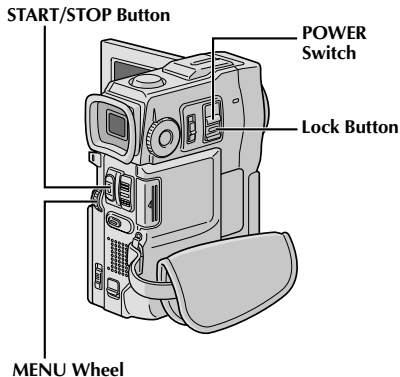

Display



Menu Screen

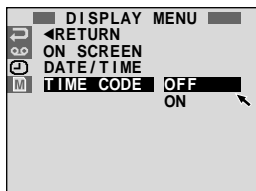

* Each setting is linked with "DISPLAY MENU", which appears when the Operation Switch is set to "M" (☞ pg. 31). The parameters are the same as in the description on pg. 31.

NOTES:

- It is also possible to change the ON SCREEN settings by pressing **DISPLAY** on the remote control (provided).
- "REC MODE" can be set when the Operation Switch is set to "M" (☞ pg. 13, 29).
- If "ON SCREEN" is set to "SIMPLE", it keeps the camcorder's display (except the date, time and time code) from appearing on the connected TV. It also makes the playback sound mode and tape speed disappear on the camcorder.

Using Menus For Detailed Adjustment

The following procedure applies to all except Synchro Comp (☞ pg. 74, 75).

- 1 Set the **POWER** Switch to "**PLAY/PC**" while pressing down the Lock Button located on the switch.
- 2 Press the **MENU** wheel. The Menu Screen appears.
- 3 Rotate the **MENU** wheel to select the desired function icon, and press it. The selected function menu appears.
- 4 Rotate the **MENU** wheel to select the desired function, and press it to display the Sub Menu.
- 5 Rotate the **MENU** wheel to select the desired parameter and press it. Selection is complete.
- 6 Rotate the **MENU** wheel to select "**◀RETURN**" and press it twice to close the Menu Screen.

VIDEO MENU	SOUND MODE	☞ pg. 44.
	12BIT MODE	☞ pg. 44.
	SYNCHRO	☞ pg. 75.
	REC MODE	Allows you to set the video recording mode (SP or LP) depending on your preference (☞ pg. 13). It is recommended you use "REC MODE" in the "VIDEO MENU" when using this camcorder as a recorder during digital dubbing (☞ pg. 63).
	BLANK SRCH	Helps find a blank portion of tape when you want to record from the middle of a tape (☞ pg. 45).
DISPLAY MENU	Ⓜ → Ⓜ COPY	ON: Enables dubbing of images recorded on a tape to a MultiMediaCard (☞ pg. 65). OFF: Enables snapshots to be taken during video playback.
	ON SCREEN*	Makes the camcorder's indications appear/disappear from the connected TV screen.
	DATE/TIME*	Makes the date/time appear/disappear on the camcorder.
	TIME CODE*	Makes the time code appear/disappear on the camcorder.

Playback Sound

During playback, the camcorder detects the sound mode in which the recording was made, and plays the sound back. Select the type of sound to accompany your playback picture. According to the menu access explanation on pg. 43, select "SOUND MODE" or "12BIT MODE" from the Menu Screen and set it to the desired parameter.

SOUND MODE	STEREO	Sound is output on both "L" and "R" channels in stereo.
	SOUND L	Sound from the "L" channel is output in stereo.
	SOUND R	Sound from the "R" channel is output in stereo.
12BIT MODE	SOUND 1	Original sound is output on both "L" and "R" channels in stereo.
	SOUND 2	Dubbed sound is output on both "L" and "R" channels in stereo.
	MIX	Original and dubbed sounds are combined and output in stereo on both "L" and "R" channels in stereo.

 : Factory-preset

NOTES:

- The "SOUND MODE" setting is available for both 12-bit and 16-bit sound. (In previous models' functions, "12-bit" is called "32 kHz" and "16-bit" is called "48 kHz".)
- The camcorder cannot detect the sound mode in which the recording was made during fast-forward or rewind. During playback the sound mode is displayed in the upper left corner.

Display

ON SCREEN setting:
For playback sound, tape speed and tape running.

12BIT / SOUND1
SP ▶

DATE/TIME setting:
For date/time.

DEC 25 '00

PM 5:30

TIME CODE setting:
For time code.

TC 12:34:24

Minutes

Seconds

Frames*

*30 frames = 1 second

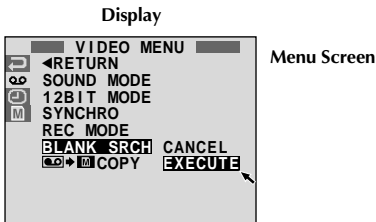
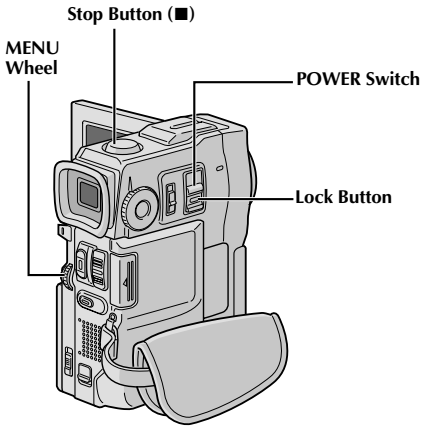

Blank Search

Helps you find where you should start recording in the middle of a tape to avoid time code interruption (☞ pg. 23).

- 1** Load a tape (☞ pg. 12) and set the **POWER Switch** to "**PLAY/PC**" while pressing down the Lock Button located on the switch.
- 2** Press the **MENU wheel**. The Menu Screen appears.
- 3** Rotate the **MENU wheel** to select "**VID**", then press it. "VIDEO MENU" appears.
- 4** Rotate the **MENU wheel** to select "BLANK SRCH", then press it. The Sub Menu appears.
- 5** Rotate the **MENU wheel** to select "EXECUTE", then press it.
 - "BLANK SEARCH" appears blinking and the camcorder automatically starts reverse or forward shuttle search, then stops at the spot which is about 3 seconds of tape before the beginning of the detected blank portion.

To cancel Blank Search midway . . .
.... press ■.

NOTES:

- In step 5, if the current position is at a blank portion the camcorder searches in the reverse direction, and if the current position is at a recorded portion the camcorder searches in the forward direction.
- Blank Search does not work if "HEAD CLEANING REQUIRED. USE CLEANING CASSETTE" has appeared with the tape.
- If the beginning or end of the tape is reached during Blank Search, the camcorder stops automatically.
- A blank portion which is shorter than 5 seconds of tape cannot be detected.
- The detected blank portion may be located between recorded scenes. Before you start recording, make sure there is no recorded scene after the blank portion.

START/STOP Button

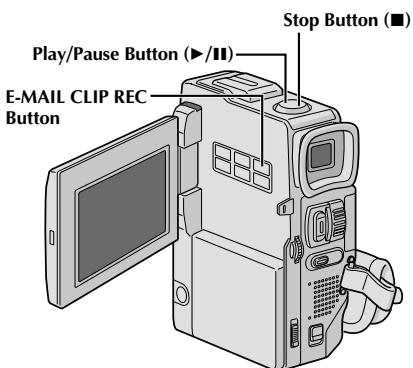
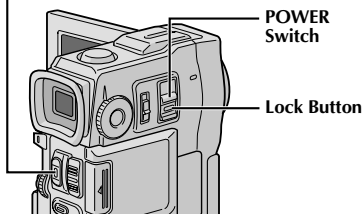

Display

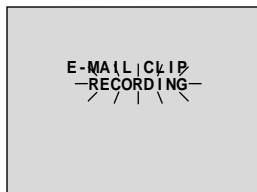

↓ After approx. 20 seconds or when **START/STOP** is pressed



↓ Storing is complete



Playback Screen

E-Mail Clip Recording

You can make video clips from recorded video footage and store them in a MultiMediaCard as files which can be conveniently sent via e-mail.

- 1** Load a MultiMediaCard (☞ pg. 14) and cassette (☞ pg. 12). Set the **POWER** Switch to "**PLAY/PC**" while pressing down the Lock Button located on the switch.
- 2** Press **▶/⏸** to start video playback.
- 3** Press **E-MAIL CLIP REC**. "E-MAIL CLIP STAND-BY" appears and the camcorder enters the E-Mail Clip Record-Standby mode.
- 4** Press **START/STOP**. "E-MAIL CLIP RECORDING" appears.
 - The camcorder stops E-Mail Clip Recording automatically after approx. 20 seconds, then starts storing the recorded video data in the MultiMediaCard which takes approx. 100 seconds additionally. "COMPLETED" appears when it is complete.

To cancel E-Mail Clip Recording . . .

.... after step 3, press **E-MAIL CLIP REC** again or press **■** to stop video playback.

To view video clips stored in a MultiMediaCard . . .

.... the video clip selected in the E-CLIP Index Screen (☞ pg. 49, Index Playback) can be viewed in the LCD monitor or viewfinder; video clips cannot be displayed on a connected TV.

NOTES:

- Playback operation cannot be performed during E-Mail Clip Recording.
- If you press **START/STOP** while E-Mail Clip Recording is in progress, only the portion which is recorded before **START/STOP** is pressed will be stored in the MultiMediaCard.
- Also, if the end of the tape is reached during E-Mail Clip Recording, that portion will be automatically stored in the MultiMediaCard.
- If the end of the tape is reached in step 3, the E-Mail Clip Record-Standby mode will be automatically canceled.
- Refer to the instruction manual of the provided software, CardNavigator, Video Player and JVC Video Decoder.
- Video noise may appear while viewing video clips in the LCD monitor or viewfinder, however, this noise is not present in the actual video clips stored in the MultiMediaCard.

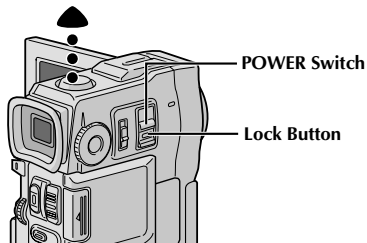
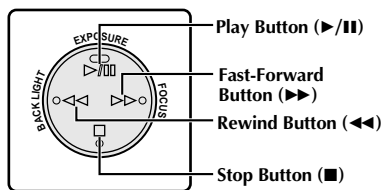

[For Normal Playback]

To display the next image

[For Auto Playback]

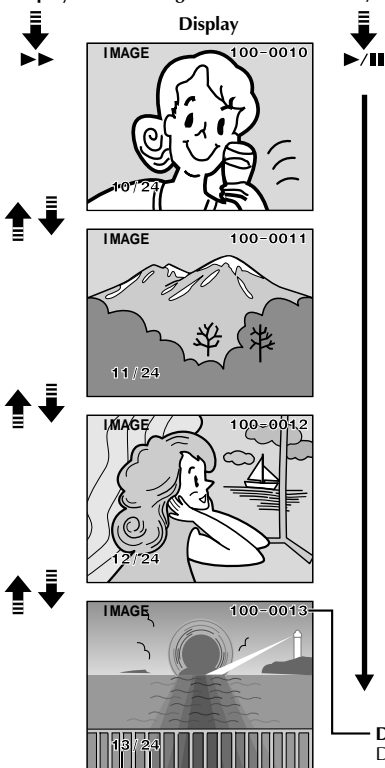

Total number of images

Displays the total number of stored images.

Image number

Displays the index number of the image file (ⓘ pg. 48, 49).

To display the previous image

Normal Playback

Images shot with the camcorder are automatically numbered, then stored in numerical order in the MultiMediaCard. You can view the stored images, one at a time, much like flipping through a photo album.

- 1 Load a MultiMediaCard (ⓘ pg. 14).
- 2 Set the **POWER** Switch to "MEMORY PLAY" while pressing down the Lock Button located on the switch. Open the LCD monitor fully or pull out the viewfinder fully.
 - A stored image is displayed.
- 3 Press ▶▶ to display the next image.
Press ◀◀ to display the previous image.

Auto Playback

You can run through all the images stored in memory automatically.

- 1 Perform steps 1 and 2 above.
- 2 Press ▶/⏸.
 - If you press ◀◀ during Auto Playback, images are displayed in descending order.
 - If you press ▶▶ during Auto Playback, images are displayed in ascending order.
- 3 To end Auto Playback, press ■.

NOTES:

- Even if you shoot a new image after playing back a low-numbered one, this will not overwrite an existing image, because new images are automatically stored after the last-recorded one.
- Image number, directory and file names appear if "ON SCREEN" is set to either "LCD" or "LCD/TV" in the Menu Screen (ⓘ pg. 31).

Directory and File names

Displays the directory and file names (ⓘ pg. 48, 49).

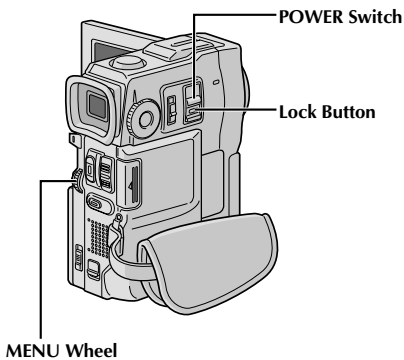
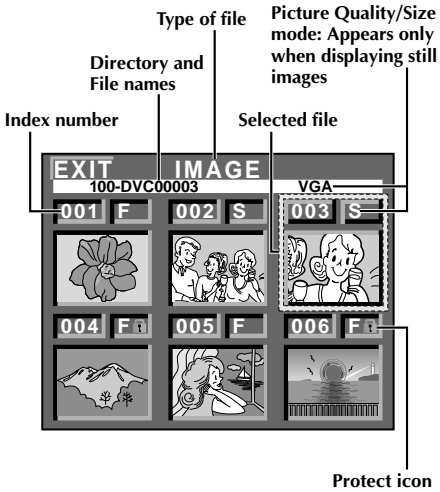

Index Screen

The files you stored can be displayed together with their index information. Convenient for checking files stored beforehand, the Index Screen also shows the Picture Quality/Size mode, directory and file names as well as which files are protected against accidental erasure.

100-DVC0003: Directory and File names

Shows that the selected file is in a directory called "100" and its file name is "DVC0003".

Each time shooting takes place, a file name is made using a number which is larger by one than the largest number of the file names which are in use. If the file name reaches DVC09999, a new directory will be made and the file name will start again from DVC00001.

In the playback screen (pg. 47), the directory and only the last four digits of the file name are displayed.

001: Index number

Index numbers are marked from 001. For example, when 10 files are stored (index number: 001 to 010), if three files with index numbers 002, 004 and 006 are deleted from memory, the remaining files are automatically moved up to fill any gaps in the numerical sequence. Therefore, the number of remaining files is 7, and the new index numbers range from 001 to 007.

F/S/XGA/VGA: Picture Quality/Size mode

Displays the Picture Quality/Size mode of the stored image. There are 4 modes available: XGA FINE, XGA STD, VGA FINE and VGA STD (in order of quality) (pg. 15).

🔒: Protect icon

When a file is protected against its accidental erasure, a padlock mark appears next to the index number, and that file cannot be deleted.

Selected File

A file is framed in green when it is selected. Rotate the MENU wheel to move the green frame to the desired file.

Index Playback

You can view or listen to the files (still images, video clips, or sound effects) stored in memory six at a time. Use this mode when looking for a file you wish to view or hear.

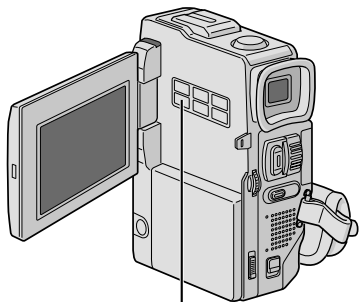

INDEX Button

Display



Playback Screen



Still image

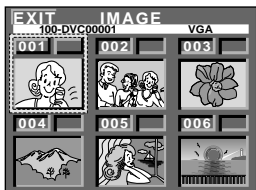

Video clip



Sound effect

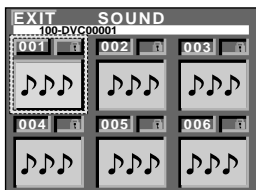

1

Perform steps **1** and **2** of "Normal Playback" on pg. 47.

2

To access the Index Screen, press **INDEX** once.

If you press INDEX twice...

the Index Screen for E-Mail Clip Rec (☞ pg. 46) appears, if a video clip has been stored. (If there is no video clip, this will be skipped.)

If you press INDEX three times...

the Index Screen for Digital Sound Effect (☞ pg. 39) appears. (If there is no sound effect, the display will return to the still image Index Screen.)

3

Rotate the **MENU** wheel to move the green frame to the desired file and press it. The file selected in the Index Screen is displayed or played back.

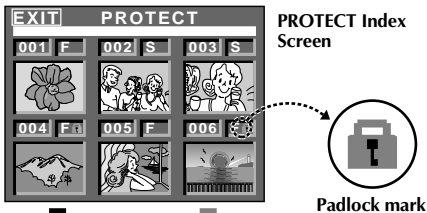
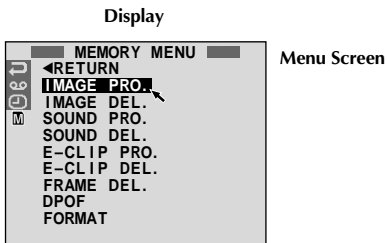
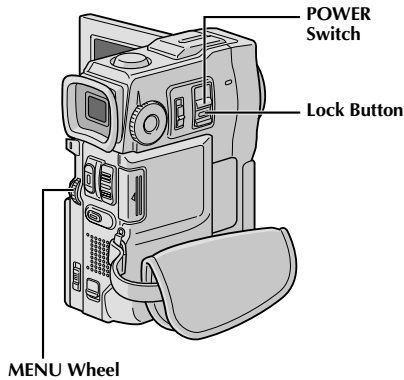

Normal playback

If Protection is removed

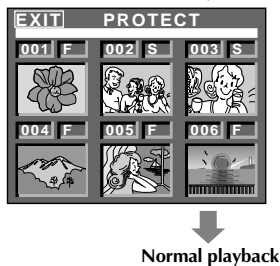

Protecting Files

The Protect mode helps prevent the accidental erasure of files. When a padlock mark is displayed next to the index number, that file cannot be deleted.

- 1** Set the **POWER** Switch to “**MEMORY PLAY**” while pressing down the Lock Button located on the switch. Open the LCD monitor fully or pull out the viewfinder fully.
 - A stored file is displayed.
- 2** Press the **MENU** wheel. The Menu Screen appears. Rotate it to select “**MEM**” and press it. “**MEMORY MENU**” appears.
- 3** By rotating the **MENU** wheel...
 - ... select “**IMAGE PRO.**” to access the PROTECT Index Screen.
 - ... select “**E-CLIP PRO.**” to access the E-Clip Rec PROTECT Index Screen.
 - ... select “**SOUND PRO.**” to access the Sound Effect PROTECT Index Screen.
 Then press the **MENU** wheel.

TO PROTECT A FILE

Before doing the following, perform steps 1 through 3 above.

- 4** Rotate the **MENU** wheel to move the green frame to the desired file and press it. A “**🔒**” padlock mark appears on the selected file. Repeat this procedure for all files you do not wish to delete by accident.
- 5** Rotate the **MENU** wheel upward to select “**EXIT**” and press it. The normal playback screen appears.

NOTE:

When the memory is initialized or corrupted, even protected files are deleted. If you do not want to lose important files, transfer them to a PC and save them.

TO REMOVE PROTECTION

Before doing the following, perform steps 1 through 3 above.

- 4** Rotate the **MENU** wheel to move the green frame to the desired file and press it. The “**🔒**” padlock mark located above the file disappears and the file is no longer protected. Repeat this procedure for all files from which you wish to remove protection.
- 5** Rotate the **MENU** wheel upward to select “**EXIT**” and press it. The normal playback screen appears.

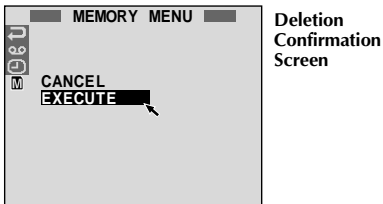
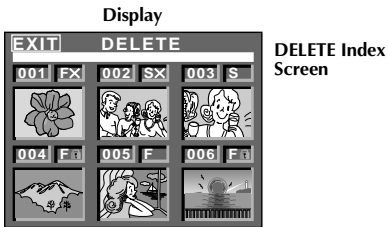
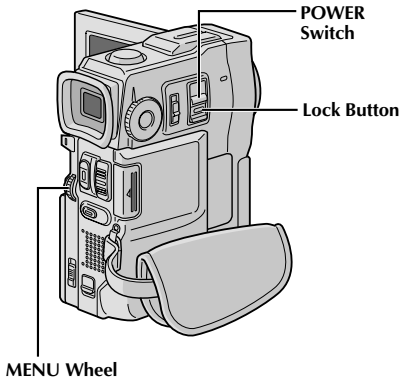

CAUTION:

Do not remove the MultiMediaCard or perform any other operation (such as turning off the camcorder) during deletion. Also, be sure to use the provided AC Power Adapter/Charger, as the MultiMediaCard may be corrupted if the battery becomes exhausted during deletion. If the MultiMediaCard becomes corrupted, initialize it. (☞ pg. 52)

Deleting Files

Previously stored files can be deleted either one at a time or all at once.

- 1 Set the **POWER** Switch to "MEMORY PLAY" while pressing down the Lock Button located on the switch. Open the LCD monitor fully or pull out the viewfinder fully.
 - A stored file is displayed.
- 2 Press the **MENU** wheel. The Menu Screen appears. Rotate it to select "M" and press it. "MEMORY MENU" appears.
- 3 By rotating the **MENU** wheel...
 - ... select "IMAGE DEL." to delete images.
 - ... select "E-CLIP DEL." to delete E-clip recording files.
 - ... select "SOUND DEL." to delete sound effects.
 Then press the **MENU** wheel. The Sub Menu appears.

TO SELECT A FILE BY BROWSING FILES STORED IN MEMORY

Before doing the following, perform steps 1 through 3 above.

- 4 Rotate the **MENU** wheel to select "SELECT" and press it. The DELETE Index Screen appears.
- 5 Rotate the **MENU** wheel to move the green frame to the desired file that you wish to delete and press it. An "X" appears above the selected file. Repeat this procedure for all files that you wish to delete. To deselect a file, press the **MENU** wheel again. The "X" disappears.
- 6 Rotate the **MENU** wheel upward to select "EXIT" and press it. The Deletion Confirmation Screen appears.
- 7 Rotate the **MENU** wheel to select "EXECUTE" and press it. The selected files are deleted and the normal playback screen appears.
 - To cancel deletion, rotate the **MENU** wheel to select "CANCEL" and press it.

TO DELETE ALL FILES

Before doing the following, perform steps 1 through 3 above.

- 4 Rotate the **MENU** wheel to select "ALL" and press it. The Deletion Confirmation Screen appears.
- 5 Rotate the **MENU** wheel to select "EXECUTE" and press it. All the files are deleted.
 - To cancel deletion, rotate the **MENU** wheel to select "CANCEL" and press it.

NOTES:

- Protected files (☞ pg. 50) cannot be deleted with the above operation. To delete them, remove protection first.
- Once files are deleted, they cannot be restored. Check files before deleting.

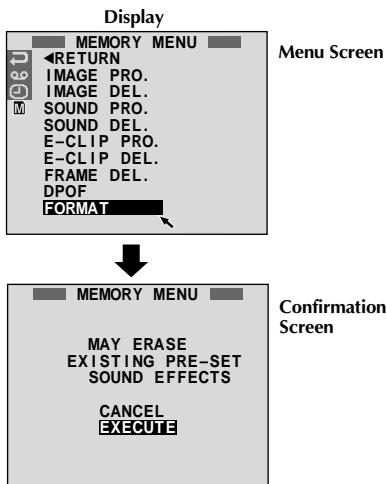
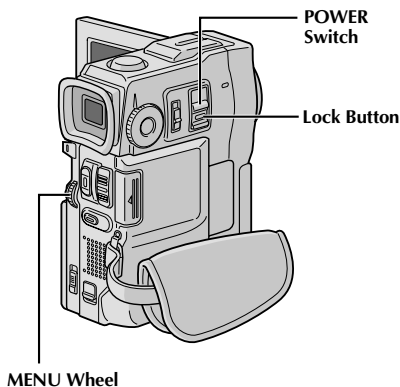

Initializing A MultiMediaCard

You can initialize a MultiMediaCard anytime. **After initialising, all images and data stored in the MultiMediaCard, including those which have been protected, are cleared.**

- 1** Set the **POWER** Switch to "MEMORY PLAY" while pressing down the Lock Button located on the switch. Open the LCD monitor fully or pull out the viewfinder fully.
- 2** Press the **MENU** wheel. The Menu Screen appears.
- 3** Rotate the **MENU** wheel to select "M" and press it. "MEMORY MENU" appears.
- 4** Rotate the **MENU** wheel to select "FORMAT" and press it. The Confirmation Screen appears.
- 5** Rotate the **MENU** wheel to select "EXECUTE" and press it. The MultiMediaCard is initialized. When initialization is finished, "NO STORED DATA" appears.
 - To cancel initialization, rotate the **MENU** wheel to select "CANCEL" and press it.

CAUTION:

Do not perform any other operation (such as turning off the camcorder) during initialization. Also, be sure to use the provided AC Power Adapter/Charger, as the MultiMediaCard may be corrupted if the battery becomes exhausted during initialization. If MultiMediaCard becomes corrupted initialize it.

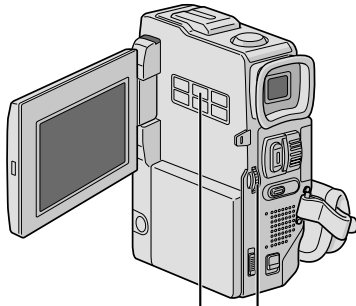

PRINT FRAME Button

MENU Wheel

Display

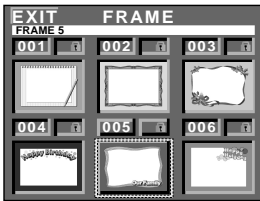

Print Frame Index Screen



Superimposing A Print Frame

A selection of print frames are stored in the camcorder. A frame can be superimposed over a still image.

- 1** Play back an image stored in the MultiMediaCard.
- 2** Press **PRINT FRAME**. The Print Frame Index Screen appears.
- 3** Rotate the **MENU** wheel to move the green frame to the desired print frame and press it. Selection is complete. The selected print frame is superimposed over the still image.

To Make The Print Frame Disappear . . .
.... press **PRINT FRAME**.

NOTES:

- A print frame created on a PC can be transferred to a MultiMediaCard using the provided software. Transferred print frames are displayed from print frame index number 007, and they can be used together with the print frames in the camcorder's memory. For details on creating/transferring print frames, refer to the software instructions.
- Depending on the images you play back, the print frame outline may become grainy or vague.

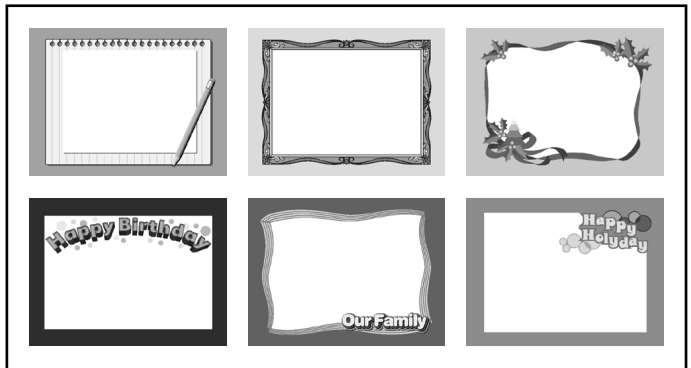

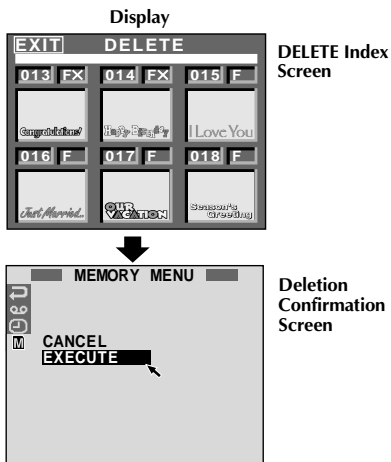
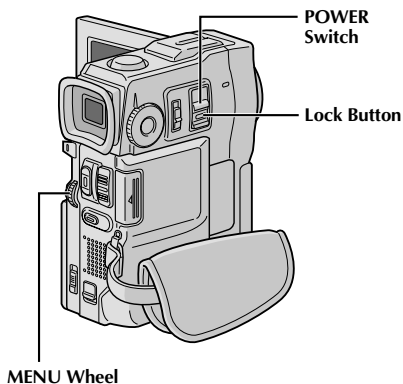

CAUTION:

Do not remove the MultiMediaCard or perform any other operation (such as turning off the camcorder) during deletion. Also, be sure to use the provided AC Power Adapter/Charger, as the MultiMediaCard may be corrupted if the battery becomes exhausted during deletion. If the MultiMediaCard becomes corrupted, initialize it. (☞ pg. 52)

Print Frame Deletion

A print frame created on a PC can be transferred to a MultiMediaCard using the provided software. Print frames that have been transferred to a MultiMediaCard can be deleted when they are no longer needed.

There are 2 ways of deleting previously created print frames: by browsing through print frames individually or by deleting them all at once.

TO SELECT A PRINT FRAME BY BROWSING PRINT FRAMES STORED IN MEMORY

- 1** Set the **POWER** Switch to "MEMORY PLAY" while pressing down the Lock Button located on the switch.
- 2** Press the **MENU** wheel. The Menu Screen appears.
- 3** Rotate the **MENU** wheel to select "M" and press it. "MEMORY MENU" appears.
- 4** Rotate the **MENU** wheel to select "FRAME DEL." and press it. The Sub Menu appears.
- 5** Rotate the **MENU** wheel to select "SELECT" and press it. The DELETED Index Screen appears.
- 6** Rotate the **MENU** wheel to move the green frame to the desired print frame that you wish to delete and press it. An "X" appears above the selected print frame. Repeat this procedure for all print frames that you wish to delete. To deselect a print frame, press the **MENU** wheel again. The "X" disappears.
- 7** Rotate the **MENU** wheel upward to select "EXIT" and press it. The Deletion Confirmation Screen appears.
- 8** Rotate the **MENU** wheel to select "EXECUTE" and press it. The selected print frames are deleted and the normal playback screen appears.
 - To cancel deletion, rotate the **MENU** wheel to select "CANCEL" and press it.

NOTES:

- If print frames created on a PC have not been transferred to a MultiMediaCard, it is not possible to delete them using these steps.
- The print frames in the camcorder's memory cannot be deleted.

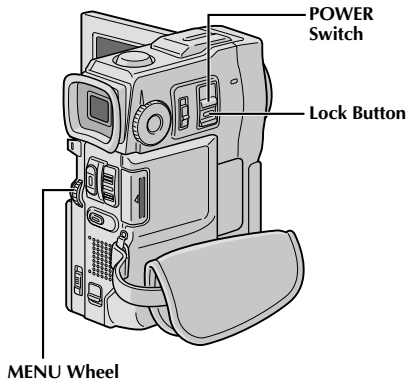

TO DELETE ALL PRINT FRAMES

- 1** Perform steps 1 through 4 on pag. 54.
- 2** Rotate the **MENU** wheel to select "ALL" and press it. The Deletion Confirmation Screen appears.
- 3** Rotate the **MENU** wheel to select "EXECUTE" and press it. All the print frames are deleted.
 - To cancel deletion, rotate the **MENU** wheel to select "CANCEL" and press it.

Display

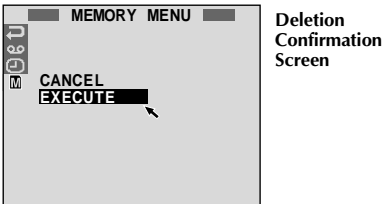
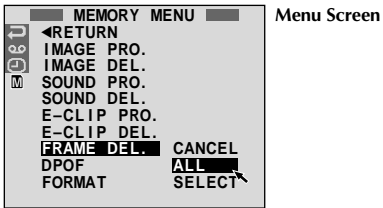

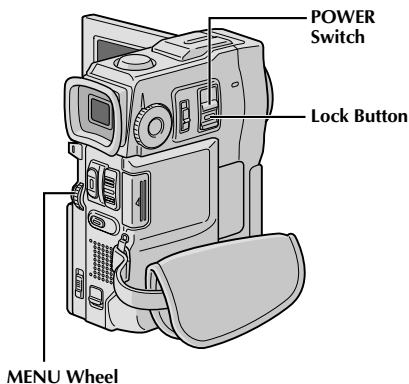

Setting Print Information (DPOF Setting)

This camcorder is compatible with the DPOF (Digital Print Order Format) standard in order to support future systems such as automatic printing, which records information about the still images you wish to print (such as the number of prints to make). There are 2 print information settings available: "To print all still images (one print for each)" explained below and "To print by selecting still images and no. of prints" (☞ pg. 57).

TO PRINT ALL STILL IMAGES (ONE PRINT FOR EACH)

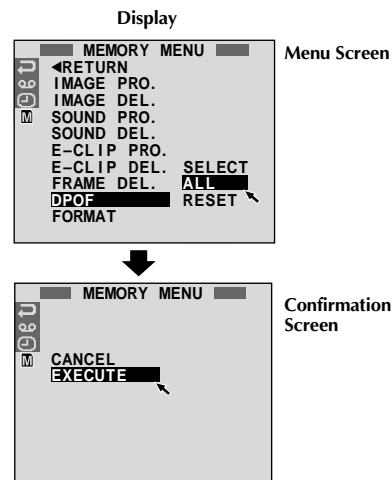

- 1** Set the **POWER** Switch to "MEMORY" while pressing down the Lock Button located on the switch. Open the LCD monitor fully or pull out the viewfinder fully.
- 2** Press the **MENU** wheel. The Menu Screen appears.
- 3** Rotate the **MENU** wheel to select "M" and press it. "MEMORY MENU" appears.
- 4** Rotate the **MENU** wheel to select "DPOF" and press it. The Sub Menu appears.
- 5** Rotate the **MENU** wheel to select "ALL" and press it. Selection is complete. The Confirmation Screen appears.
- 6** Rotate the **MENU** wheel to select "EXECUTE" and press it. The normal playback screen appears.
 - To cancel selection, rotate the **MENU** wheel to select "CANCEL" and press it.

To Reset The Setting . . .

.... select "RESET" in step 5. The setting is reset to 0 for all still images.

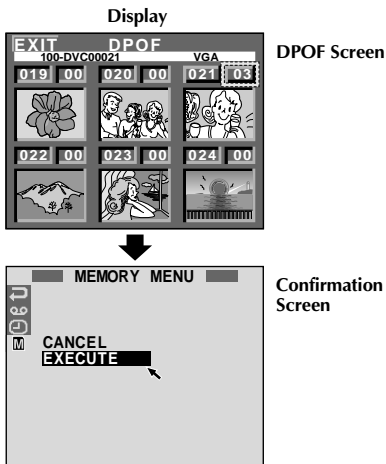
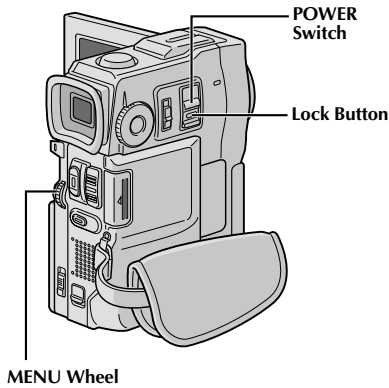

TO PRINT BY SELECTING STILL IMAGES AND NO. OF PRINTS

- 1** Perform steps 1 through 4 on pg. 56.
- 2** Rotate the **MENU** wheel to select "SELECT" and press it. Selection is complete. The DPOF Screen appears.
- 3** Rotate the **MENU** wheel to move the green frame to the image you wish to print and press it.
- 4** Select the number of prints by rotating the **MENU** wheel towards "+" to increase the number, or towards "-" to decrease the number and press it. Repeat steps 3 and 4 for the desired number of prints.
 - The number of prints can be set up to 15.
 - To correct the number of prints, select the image again and change the number.
- 5** Rotate the **MENU** wheel upward to select "EXIT" and press it. Selection is complete. The Confirmation Screen appears.
- 6** Rotate the **MENU** wheel to select "EXECUTE" and press it. The normal playback screen appears.
 - To cancel selection, rotate the **MENU** wheel to select "CANCEL" and press it.

To Reset The No. Of Prints . . .

.... select "RESET" in step 5 on pg. 56. The number of prints is reset to 0 for all still images.

CAUTION:

While performing the above, never disconnect power, as this may cause the memory to be corrupted. For safety, all buttons including the **POWER** Switch are disabled in step 5.

NOTES:

- If you load a MultiMediaCard already set as shown above in a printer compatible with DPOF, it will make prints of the selected still images automatically.
- To print images recorded on a tape, first dub them to a MultiMediaCard (pg. 65).

These are some basic types of connections. When making the connections, refer also to your VCR and TV instruction manuals.

A. Connection to a TV or VCR equipped with an S-VIDEO IN and A/V input connectors

When connecting to a TV or VCR, use the provided Docking Station, an optional Audio/Video cable and S-Video cable.

Docking Station Attachment

First align the camcorder direction stud and screw on the Docking Station with the camcorder's stud hole and tripod mounting socket and tighten the screw. When removing the camcorder, loosen the screw and detach the camcorder.

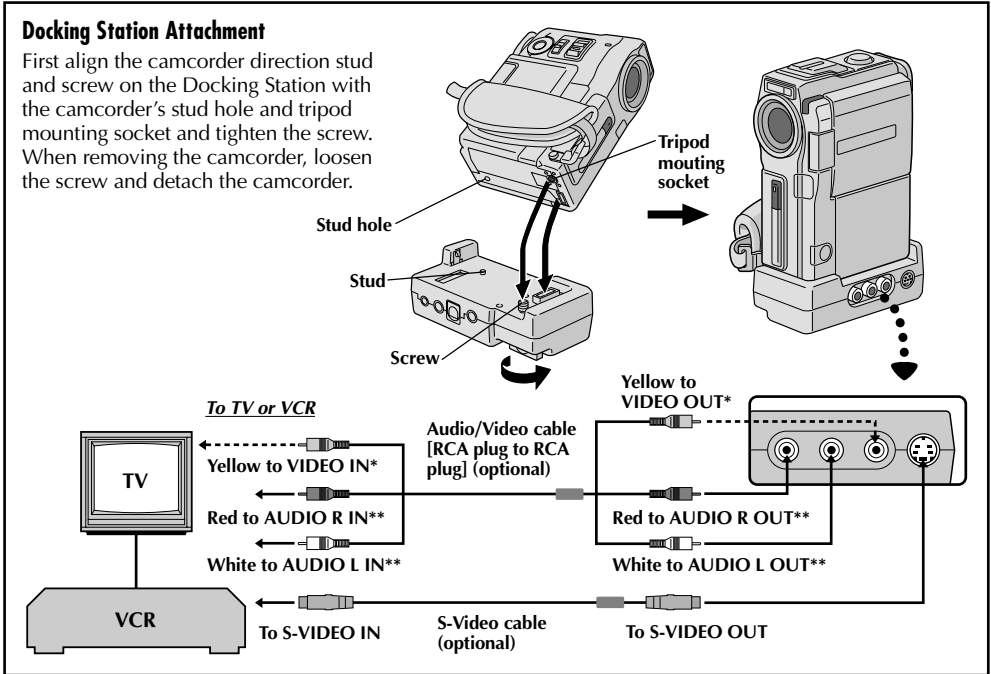

* Connect when an S-Video cable is not used.

** The Audio cable is not required for watching still images with the **POWER** Switch set to "MEMORY PLAY".

B. Connection to a TV or VCR equipped only with A/V input connectors

Use the provided Audio/Video cable.

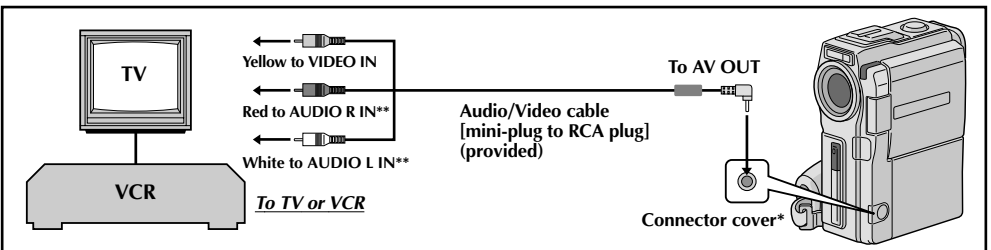

* When connecting the cables, open this cover.

** The Audio cable is not required for watching still images with the **POWER** Switch set to "MEMORY PLAY".

- 1** Make sure all units are turned off.
- 2** Connect the camcorder to a TV or VCR as shown in the illustration (☞ pg. 58).
*If using a VCR . . . go to step 3.
If not . . . go to step 4.*
- 3** Connect the VCR output to the TV input, referring to your VCR's instruction manual.
- 4** Turn on the camcorder, the VCR and the TV.
- 5** Set the VCR to its AUX input mode, and set the TV to its VIDEO mode.

To choose whether or not the following displays appear on the connected TV . . .

- Date/Time
.... set "DATE/TIME" to "AUTO", "ON" or "OFF" in the Menu Screen (☞ pg. 43).
- Time Code
.... set "TIME CODE" to "ON" or "OFF" in the Menu Screen (☞ pg. 43).
- Playback Sound Mode, Tape Speed And Tape Running Displays for video playback
Or
Directory/File Names and Image Number/Total Number of Images for D.S.C. Playback
.... set "ON SCREEN" to "LCD" or "SIMPLE" in the Menu Screen (☞ pg. 43).
Or, press **DISPLAY** on the remote control.

NOTES:

- *It is recommended to use the AC Power Adapter/Charger as the power supply instead of the battery pack (☞ pg. 9).*
- *The S-Video cable and Audio/Video cable (RCA plug to RCA plug) are optional. Be sure to use the following:*
 - *S-Video cable: YTU94146A*
 - *Audio/Video cable (RCA plug to RCA plug): YTU94147A*
- *Consult the JVC Service Center described on the sheet included in the package for details on their availability. Make sure to connect the ends with a core filter to the camcorder. The core filter reduces interference.*
- *To monitor the picture and sound from the camcorder without inserting a tape or MultiMediaCard, set the camcorder's POWER Switch to "CAMERA", then set your TV to the appropriate input mode.*
- *Make sure you adjust the TV sound volume to its minimum level to avoid a sudden burst of sound when the camcorder is turned on.*
- *If you have a TV or speakers that are not specially shielded, do not place the speakers adjacent to the TV as interference will occur in the camcorder playback picture.*
- *When a cable is connected to the AV OUT connector, the sound is not heard from the speaker.*

PC with DV
connector-equipped
capture board

PC

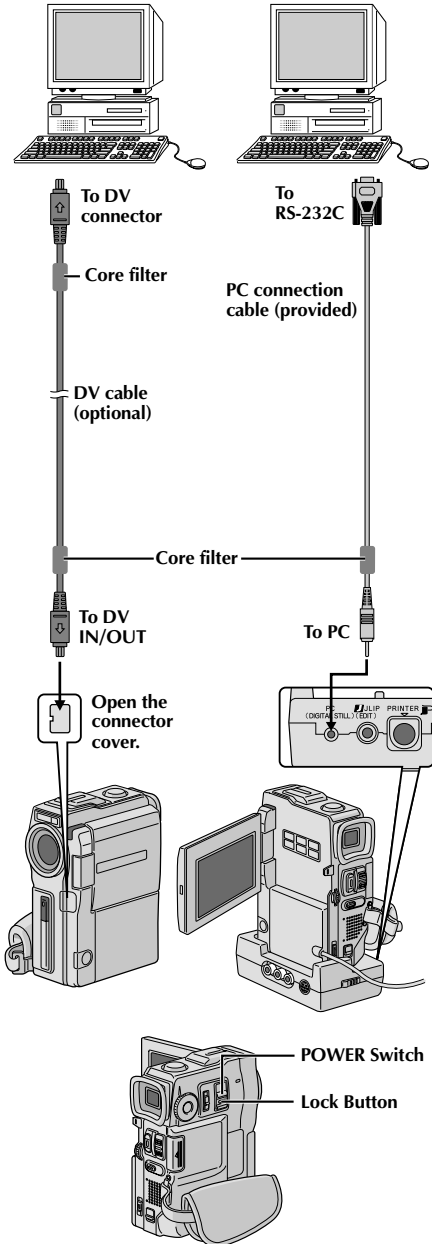

Connection To A Personal Computer

This camcorder can transfer still images to a PC by using the provided software when connected as shown in the illustration. It is also possible to transfer still images to a PC with a DV connector-equipped capture board installed.

- 1 Make sure the camcorder and PC are turned off.
- 2 Connect the camcorder or Docking Station to your PC using the appropriate cable as shown in the illustration.
 - To attach the camcorder to Docking Station, refer to "Docking Station Attachment" on pg. 58.
- 3 Turn the camcorder's **POWER** Switch to "**PLAY/PC**" while pressing down the Lock Button located on the switch and turn on the PC.

NOTES:

- It is recommended to use the AC Power Adapter/Charger as the power supply instead of the battery pack (pg. 9).
- Never connect the PC connection cable and the DV cable simultaneously to the camcorder. Connect only the cable you wish to use to the camcorder.
- The date/time information cannot be captured into the PC.
- Refer to the instruction manuals of the provided Software.
- Also refer to the manufacturer's instruction manual for the DV connector-equipped capture board.
- When using a DV cable, be sure it has a core filter attached. The core filter reduces interference.

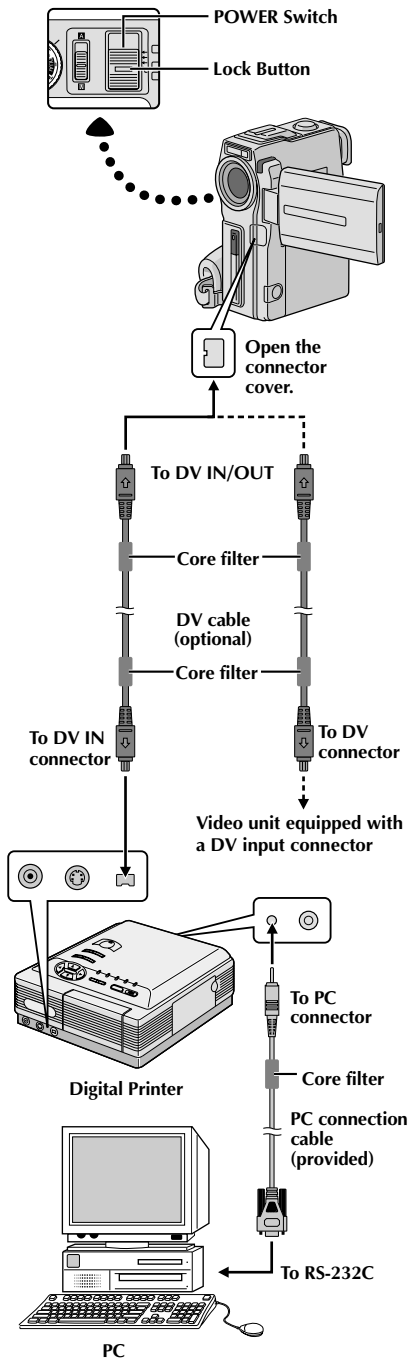

Connection To A Video Unit Equipped With A DV Connector

Connection to the GV-DT3 Digital Printer (optional) allows you to print out images or transfer them to a PC. It is also possible to copy recorded scenes from the camcorder onto another video unit equipped with a DV connector. This function is called Digital Dubbing (☞ pg. 63), which offers virtually no image or sound deterioration.

- 1** Make sure all units are turned off.
- 2** Make connections to the device you want to connect to using a DV cable, as shown in the illustration.
- 3** If necessary, connect the PC connection cable (provided) to the printer's PC connector and the PC's RS-232C connector.
- 4** Turn the camcorder's **POWER Switch** to "**PLAY/PC**" while pressing down the **Lock Button** located on the switch and turn on the other units.

NOTES:

- *It is recommended to use the AC Power Adapter/Charger as the power supply instead of the battery pack (☞ pg. 9).*
- *For Digital Dubbing, this camcorder can be connected only to one device at a time. This camcorder can also be used as a recorder (☞ pg. 63).*
- *If Still Playback, Slow-Motion Playback, Fast-Forward or Rewind is attempted with the camcorder connected to a video unit via the DV connector, the image will take on an effect similar to a colored mosaic pattern or it will become black.*
- *Also refer to the instruction manuals of the connected units.*
- *When using a DV cable, be sure it has a core filter attached. The core filter reduces interference.*

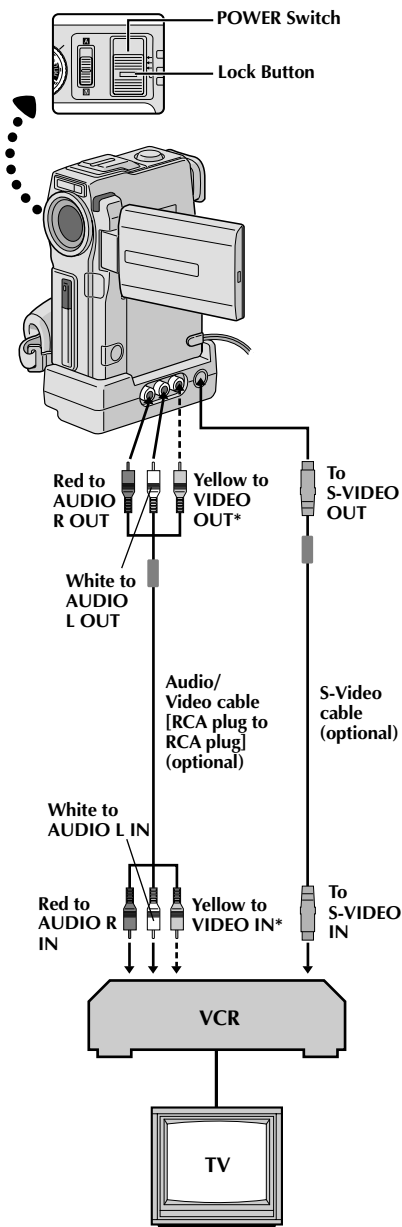

Dubbing To A VCR

- 1** Following the illustration, connect the camcorder and the VCR. Also refer to pg. 58 and 59.
- 2** Set the camcorder's **POWER Switch** to "**PLAY/PC**" while pressing down the Lock Button located on the switch, turn on the VCR's power, and insert the appropriate cassettes in the camcorder and the VCR.
- 3** Engage the VCR's AUX and Record-Pause modes.
- 4** Engage the camcorder's Play mode to find a spot just before the edit-in point. Once it is reached, press **▶/||** on the camcorder.
- 5** Press **▶/||** on the camcorder and engage the VCR's Record mode.
- 6** Engage the VCR's Record-Pause mode and press **▶/||** on the camcorder.
- 7** Repeat steps **4** through **6** for additional editing, then stop the VCR and camcorder when finished.

NOTES:

- *The S-Video cable and Audio/Video cable (RCA plug to RCA plug) are optional. Be sure to use the following:*
 - *S-Video cable: YTU94146A*
 - *Audio/Video cable (RCA plug to RCA plug): YTU94147A*
- *Consult the JVC Service Center described on the sheet included in the package for details on their availability. Make sure to connect the ends with a core filter to the camcorder. The core filter reduces interference.*
- *You can use the AV OUT connector on the camcorder for connection.*
- *You can use Playback Zoom (☞ pg. 68) or Playback Special Effects (☞ pg. 69) in step 5.*
- *Before you start dubbing, make sure that the indications do not appear on the connected TV. If they do, they are being recorded onto the new tape.*

To choose whether or not the following displays appear on the connected TV . . .

- Date/Time
.... set "DATE/TIME" to "AUTO", "ON" or "OFF" in the Menu Screen (☞ pg. 43).
- Time Code
.... set "TIME CODE" to "ON" or "OFF" in the Menu Screen (☞ pg. 43).
- Playback Sound Mode, Tape Speed And Tape Running Displays
.... set "ON SCREEN" to "LCD" or "SIMPLE" in the Menu Screen (☞ pg. 43). Or, press **DISPLAY** on the remote control.

* Connect when an S-Video cable is not used.

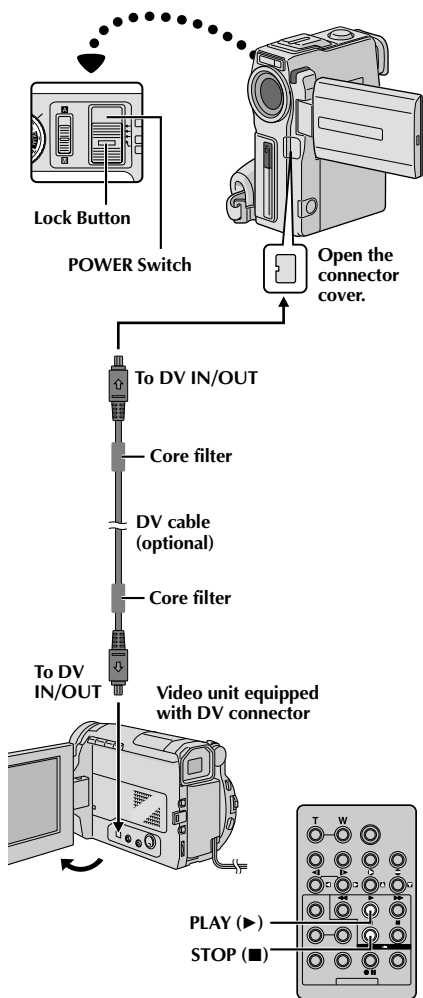

Dubbing To Or From A Video Unit Equipped With A DV Connector (Digital Dubbing)

It is also possible to copy recorded scenes from the camcorder onto another video unit equipped with a DV connector. Since a digital signal is sent, there is little if any image or sound deterioration.

[To use this camcorder as a player]

- 1 Make sure the camcorder's power is off.
- 2 Connect the camcorder to your video unit equipped with a DV connector using a DV cable as shown in the illustration.
- 3 Press **▶** to play back the source tape.
- 4 While watching the playback on the monitor, engage the DV connector-equipped video unit's record mode from the spot on the source tape you want to begin recording.

NOTES:

- **It is recommended to use the AC Power Adapter/Charger as the power supply instead of the battery pack** (☞ pg. 9).
- If the remote control is used when both the player and recorder are JVC video units, both units will perform the same operation. To prevent this from happening, press the buttons on both units.
- For Digital Dubbing, this camcorder can be connected only to one device at a time. This camcorder can also be used as a recorder.
- If a blank portion or disturbed image is played back on the player during dubbing, the dubbing may stop so that an unusual image is not dubbed.
- Even though the DV cable is connected correctly, sometimes the image may not appear in step 3. If this occurs, turn off the power and make connections again.
- If "Playback Zoom" (☞ pg. 68), "Playback Special Effects" (☞ pg. 69) or "Snapshot" is attempted during playback, only the original playback image recorded on the tape is output from the DV IN/OUT connector.
- **When using a DV cable, be sure it has a core filter attached. The core filter reduces interference.**

To Use This Camcorder As A Recorder . . .

1. Set the **POWER Switch** to "**PLAY/PC**" while pressing down the **Lock Button** located on the switch.
2. Set "**REC MODE**" to "**SP**" or "**LP**" in the Menu Screen (☞ pg. 43)
3. Connect the DV cable as shown in the illustration and load a cassette to record on.
4. Press **START/STOP** to engage the Record-Pause mode. "**DV IN**" appears on the screen.
5. Press **START/STOP** to start recording. "**DV IN**" changes to "**DV IN**".
6. Press **START/STOP** again to engage the Record-Pause mode. "**DV IN**" returns to "**DV IN**".

NOTES:

- Digital Dubbing is performed in the sound mode recorded on the original tape, regardless of the current "**SOUND MODE**" setting (☞ pg. 29).
- During Digital Dubbing, no signals are output from the **AV OUT** connector.

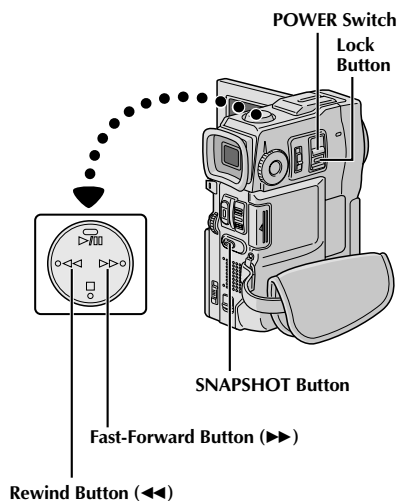

Display



Dubbing Images Stored In A MultiMediaCard To A Tape

Images can be dubbed from a MultiMediaCard to a tape.

- 1** Load a MultiMediaCard (☞ pg. 14) and cassette (☞ pg. 12).
- 2** Set the **POWER** Switch to "**PLAY/PC**" while pressing down the **Lock Button** located on the switch. Open the LCD monitor fully or pull out the viewfinder fully.
- 3** To locate the point where you wish to dub a still image, play back the tape. Stop playback at the desired point.
- 4** Set the **POWER** Switch to "**MEMORY PLAY**" while pressing down the **Lock Button** located on the switch. To select a still image to be dubbed, perform Index Playback (☞ pg. 49), Auto Playback (☞ pg. 47) or press ◀◀ or ▶▶ to select the image you wish.
- 5** To engage Dub-Standby, press **SNAPSHOT**. The message "TO COPY TO TAPE PUSH "SNAPSHOT"" appears.
- 6** While the message is being displayed, press **SNAPSHOT** again. The selected still image is recorded on the tape for approx. 6 seconds.
 - The **REC** indicator disappears when dubbing is complete.

NOTES:

- If **SNAPSHOT** is pressed in step 5 when the tape's erase protection tab is set to "SAVE", the message "COPYING FAILED" is displayed.
- The XGA image is dubbed onto the tape at 720 x 480 pixels.
- You can superimpose a print frame over the selected still image to be dubbed (☞ pg. 53) and dub it to a tape. After step 4, superimpose a print frame over the still image and go to step 5.

Dubbing Images Recorded On A Tape To A MultiMediaCard

Images can be dubbed from a tape to a MultiMediaCard.

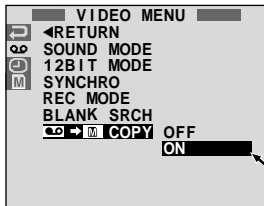
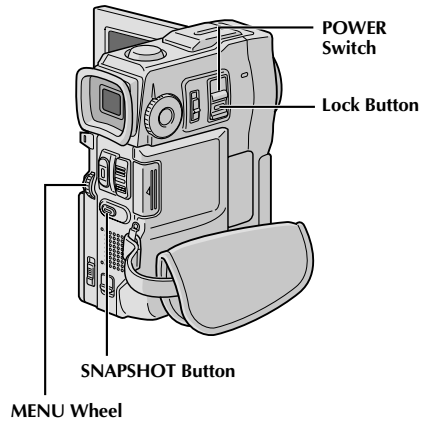

Play/Pause Button (▶/II)

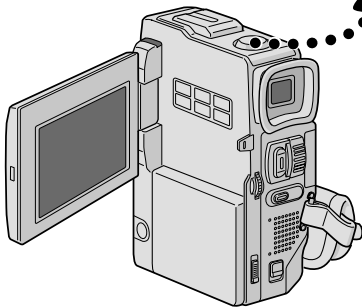
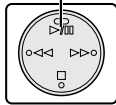

Display

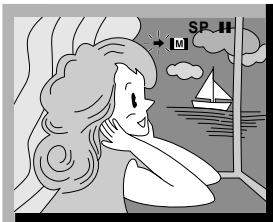

- 1** Load a MultiMediaCard (☞ pg. 14) and cassette (☞ pg. 12).
- 2** Set the **POWER** Switch to "**PLAY/PC**" while pressing down the **Lock Button** located on the switch. Open the LCD monitor fully or pull out the viewfinder fully.
- 3** Press the **MENU** wheel. The Menu Screen appears. Rotate it to select "**CO**" and press it. "VIDEO MENU" appears.
- 4** Rotate the **MENU** wheel to select "**CO → M COPY**" and press it. The Sub Menu appears. Rotate it to select "ON" and press it. Selection is complete.
- 5** Rotate the **MENU** wheel to select "**◀RETURN**" and press it twice. The normal playback screen resumes.
- 6** To select a video image to be dubbed, start playback by pressing **▶/II**. At the moment you find the image you wish to dub, press it again to engage Still Playback.
- 7** To start dubbing, press **SNAPSHOT**. The selected image is stored in the MultiMediaCard.
 • "▶" blinks during dubbing.

NOTES:

- If **SNAPSHOT** is pressed in step 7 when a MultiMediaCard is not loaded, the message "COPYING FAILED" is displayed.
- If an image recorded on the tape using the **WIDE** mode (☞ pg. 30) is dubbed to a MultiMediaCard, the **WIDE** mode identifying signal is not dubbed with it.
- To use Playback Special Effects with a video image you wish to dub, perform up to step 7 using the remote control (provided) (☞ pg. 69).
- Images are dubbed in VGA file size.

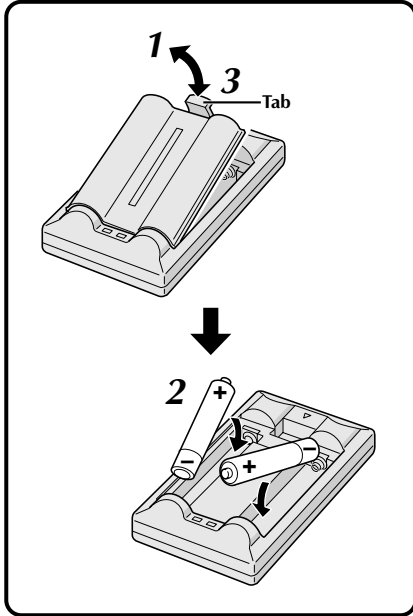

The Full-Function Remote Control Unit can operate this camcorder from a distance as well as the basic operations (Playback, Stop, Pause, Fast-Forward and Rewind) of your VCR. It also makes additional playback functions possible.

Installing The Batteries

The remote control uses two "AAA (R03)" size batteries. See "General Battery Precautions" (☞ pg. 93).

- 1** Remove the battery compartment cover while pushing up the tab as illustrated.
- 2** Insert two "AAA (R03)" size batteries in the correct direction.
- 3** Re-attach the battery compartment cover.

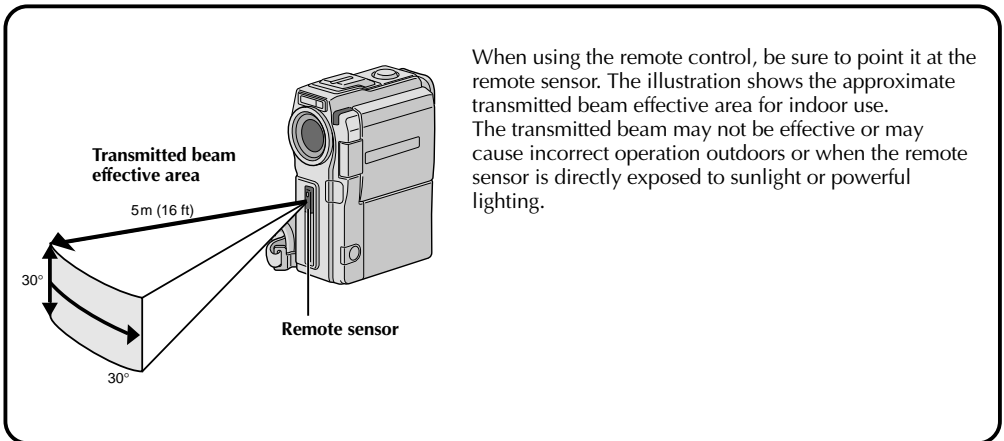

When using the remote control, be sure to point it at the remote sensor. The illustration shows the approximate transmitted beam effective area for indoor use. The transmitted beam may not be effective or may cause incorrect operation outdoors or when the remote sensor is directly exposed to sunlight or powerful lighting.

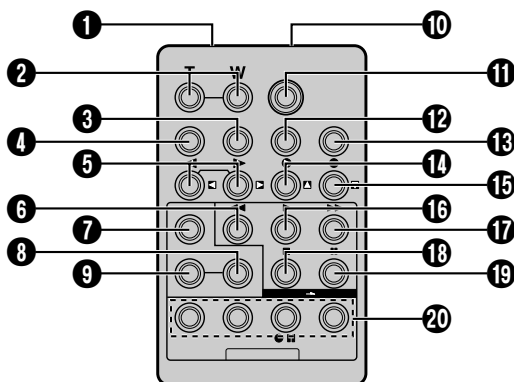

Buttons	Functions	
	With the camcorder's POWER Switch set to the camera position ("CAMERA").	With the camcorder's POWER Switch set to "PLAY/PC" or "MEMOCARD PLAY".
❶ Infrared beam transmitting window	Transmits the beam signal.	
❷ Zoom (T/W) Buttons	Zoom in/out (☞ pg. 22)	Zoom in/out (☞ pg. 68)
❸ DISPLAY Button	—	☞ pg. 71
❹ SHIFT Button	—	☞ pg. 68, 70
❺ SLOW Rewind/Forward Buttons Left/Right Buttons	— —	☞ pg. 68 ☞ pg. 68
❻ REW Button	—	<ul style="list-style-type: none"> • Rewind/Reverse Shuttle Search on a tape (☞ pg. 42) • Displays previous image in a MultiMediaCard (☞ pg. 47)
❼ FADE/WIPE Button	—	☞ pg. 72
❽ EFFECT ON/OFF Button	—	☞ pg. 69
❾ EFFECT Button	—	☞ pg. 69
❿ PAUSE IN Connector	—	☞ pg. 71
⓫ START/STOP Button	Functions the same as START/STOP on the camcorder.	
⓬ MBR SET Button	—	☞ pg. 70
⓭ SNAPSHOT Button	Functions the same as SNAPSHOT on the camcorder.	
⓮ Up Button INSERT Button*	— —	☞ pg. 68 —
⓯ Down Button A. DUB Button	— —	☞ pg. 68 ☞ pg. 76
⓰ PLAY Button	—	<ul style="list-style-type: none"> • Starts Playback of a tape (☞ pg. 42) • Starts Auto Playback of a MultiMediaCard (☞ pg. 47)
⓱ FF Button	—	<ul style="list-style-type: none"> • Forward/Forward Shuttle Search on a tape (☞ pg. 42) • Displays next image in a MultiMediaCard (☞ pg. 47)
⓲ STOP Button	—	<ul style="list-style-type: none"> • Stops the tape (☞ pg. 42) • Stops Auto Playback (☞ pg. 47)
⓳ PAUSE Button	—	Pauses the tape (☞ pg. 68)
⓴ R.A.EDIT Buttons	—	☞ pg. 70 – 75

* This function is unavailable with this camcorder.

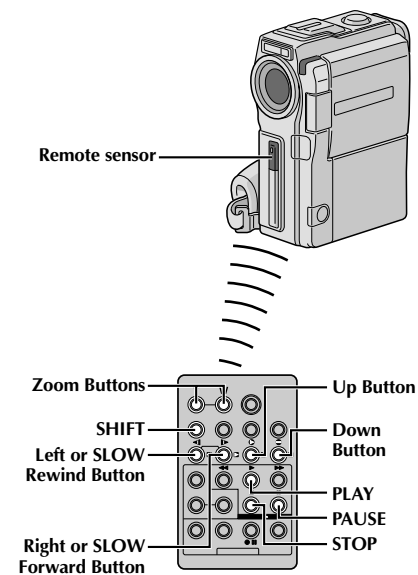

Normal playback



Press T



To move image, press **◀** (Right) while keeping **SHIFT** held down.

FEATURE: Slow-Motion Playback

PURPOSE:

To allow slow-speed search in either direction during video playback.

OPERATION:

- 1) To change from normal to Slow-Motion Playback, press **SLOW** (**◀** or **▶**) more than approx. 2 seconds. After approx. 1 minute in Slow Rewind or approx. 2 minutes in Slow Forward, normal playback resumes.
 - To stop Slow-Motion Playback, press **PLAY** (**▶**).

NOTES:

- You can also engage Slow-Motion Playback from Still Playback by pressing **SLOW** more than approx. 2 seconds.
- During Slow-Motion Playback, due to digital image processing, the picture may take on a mosaic effect.
- After **SLOW** (**◀** or **▶**) is pressed and held, the still image may be displayed for a few seconds, followed by a blue screen for a few seconds. This is not a malfunction.
- There may be a small margin between the slow-motion playback start point you chose and the actual start point for Slow-Motion Playback.
- During Slow-Motion Playback, there will be disturbances in video and the picture may seem unstable, especially with steady images. This is not a malfunction.
- During Slow-Motion Playback, press **PAUSE** (**⏸**) to pause playback.

FEATURE: Frame-By-Frame Playback

PURPOSE:

To allow frame-by-frame search during video playback.

OPERATION:

- 1) To change from normal to Frame-By-Frame Playback, press **SLOW** (**▶**) repeatedly for forward or **SLOW** (**◀**) repeatedly for reverse. Each time it is pressed, the frame is played back.

NOTE:

You can also engage Frame-By-Frame Playback from Still Playback by pressing **SLOW** (**◀** or **▶**) repeatedly.

FEATURE: Playback Zoom

PURPOSE:

To magnify the recorded image up to 10X at any time during playback.

OPERATION:





- 1) Press **PLAY** (**▶**) to find the scene of interest.
- 2) Press the Zoom Buttons (**T/W**) on the remote control. Make sure the remote control is pointed at the camcorder's remote sensor. Pressing **T** zooms in.
- 3) You can move the image on screen around to find a particular portion of the picture. While holding down **SHIFT**, press **◀** (Left), **▶** (Right), **▲** (Up) and **▼** (Down).
 - To end zoom, press and hold **W** until magnification returns to normal. Or, press **STOP** (**■**) and then press **PLAY** (**▶**).

NOTES:

- Zoom can also be used during slow-motion and still playback.
- Due to digital image processing, the quality of the image may suffer.
- Playback Zoom cannot be used on images that were recorded with the **MODE Dial** set to "**PS**".

PLAYBACK EFFECT

▶OFF

- 1  CLASSIC FILM
- 2  B/W MONOTONE
- 3  SEPIA
- 4  STROBE
- 5  VIDEO ECHO

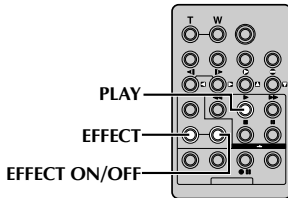
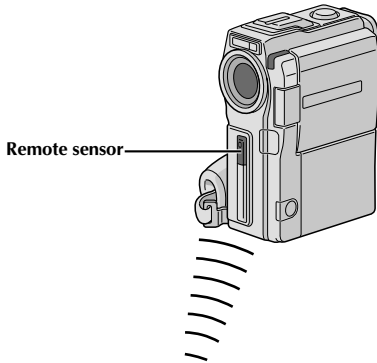
PLAYBACK
EFFECT Select
Menu**FEATURE: Playback Special Effects****PURPOSE:**

To allow you to add creative effects to the video playback image.

OPERATION:

- 1) To start playback, press **PLAY** (▶).
- 2) Point the remote control at the camcorder's remote sensor and press **EFFECT**. The **PLAYBACK EFFECT Select Menu** appears.
- 3) Move the highlight bar to the desired effect by pressing **EFFECT**. The selected function is activated and after 2 seconds the menu disappears.
 - To deactivate the selected effect, press **EFFECT ON/OFF** on the remote control. Pressing it again re-activates the selected effect.
 - To change the selected effect, repeat from step 2 above.

NOTE:

The effects that can be used during playback are Classic Film, Monotone, Sepia, Strobe and Video Echo. The effects work the same in playback as they did in recording. Refer to page 38 for more information.

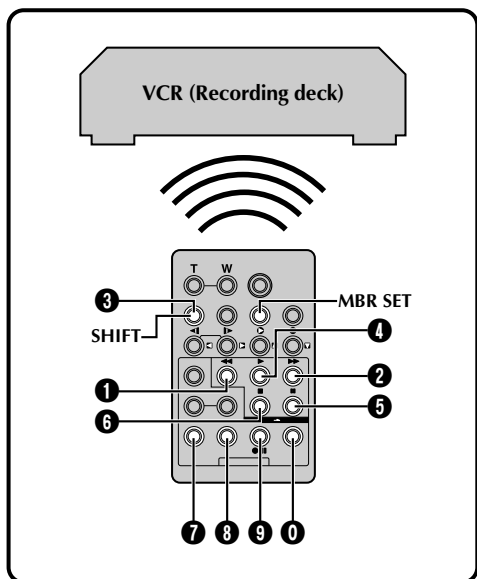

VCR CODE LIST

VCR BRAND NAME	BUTTONS (A) (B)	VCR BRAND NAME	BUTTONS (A) (B)
GE	1 1	PHILIPS	3 3
	9 2		7 2
	9 0	PANASONIC	1 3
	9 4		1 7
HITACHI	6 6		1 1
	6 3		9 4
JVC A	9 1	RCA	1 8
	9 6		9 2
	9 3		9 4
MAGNAVOX	9 5		6 6
	1 1	6 3	
	7 1	9 0	
	7 6	SANYO	3 6
MITSUBISHI	6 7		3 5
	6 8	SHARP	1 5
NEC	3 7		1 0
	3 8	SONY	6 5
PHILIPS	1 9		6 0
	9 5		3 9
	1 1		3 1
	9 4	TOSHIBA	6 9
	9 1		6 1
	9 6	ZENITH	1 6
	1 2		

Random Assemble Editing [R.A.Edit]

Create edited videos easily using your camcorder as the source player. You can select up to 8 "cuts" for automatic editing, in any order you like. R.A.Edit is more easily performed when the MBR (Multi-Brand Remote) is set to operate with your brand of VCR (see VCR CODE LIST), but can also be performed by operating the VCR manually.

Before operation, make sure the batteries are installed in the remote control (pg. 66).

SET REMOTE/VCR CODE

1 Turn off the power to the VCR and point the remote towards the VCR's infrared sensor. Then, referring to the VCR CODE LIST, press and hold **MBR SET**, and press button (A) and then (B). The code is automatically set once you release **MBR SET**, and the VCR's power comes on.

2 Make sure the VCR's power is on. Then, while holding **SHIFT**, press the button on the remote for the desired function. The functions the remote can control are PLAY, STOP, PAUSE, FF, REW and VCR REC STBY (you do not need to press **SHIFT** for this one).

You are now ready to try Random Assemble Editing.

IMPORTANT

Although the MBR is compatible with JVC VCRs and those of many other makers, it may not work with yours or may offer limited functions.

NOTES:

- If the VCR's power does not come on in step 1, try another code from the VCR CODE LIST.
- Some brands of VCR do not come on automatically. In this case, turn the power on manually and try step 2.
- If the remote control is not able to control the VCR, use the controls on the VCR.
- When the remote control's batteries run out, the VCR brand you have set will be erased. In that case, replace the old battery with a new one to reset the VCR brand.

MAKE CONNECTIONS

Also refer to pg. 58 and 59.

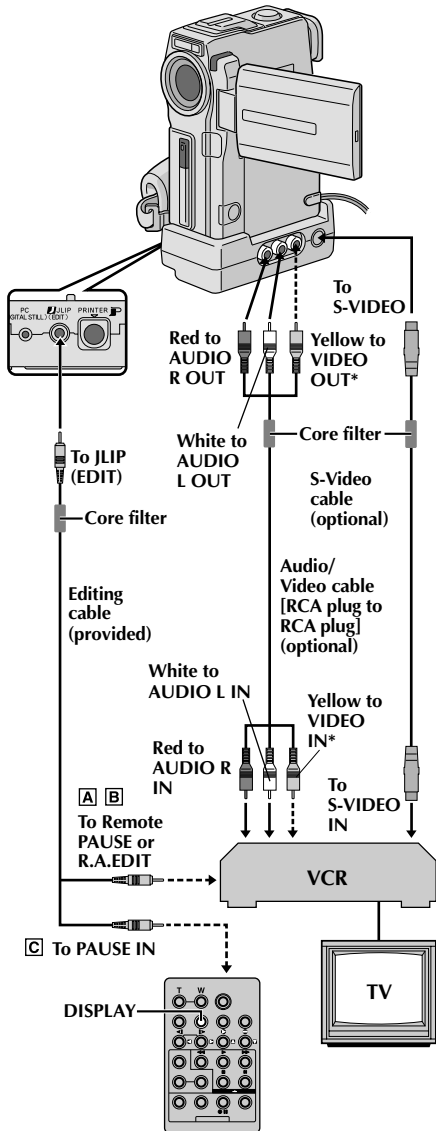

* Connect when an S-Video cable is not used.

ATTENTION FOR EDITING CABLE

- Be careful not to mistake it for the JLIP cable (☞ pg. 6).
- Make sure you connect the end with the core filter to the camcorder.

1 **A** A JVC VCR equipped with a remote pause connector . . .

... connect the editing cable to the Remote PAUSE connector.

B A JVC VCR not equipped with a remote pause connector but equipped with an R.A. EDIT connector . . .

... connect the editing cable to the R.A.EDIT connector.

C A VCR other than above . . .

... connect the editing cable to the remote control's PAUSE IN connector.

2 Insert a recorded tape into the camcorder and set the **POWER** Switch to "**PLAY/PC**" while pressing down the Lock Button located on the switch.

3 Turn the VCR power on, insert a recordable tape and engage the AUX mode (refer to the VCR's instructions).

NOTES:

- Before Random Assemble Editing, make sure the indications do not appear on the TV monitor. If they do, they will be recorded onto the new tape.

To choose whether or not the following displays appear on the connected TV . . .

- Date/Time
 - set "DATE/TIME" to "AUTO", "ON" or "OFF" in the Menu Screen (☞ pg. 43).
 - Time Code
 - set "TIME CODE" to "ON" or "OFF" in the Menu Screen (☞ pg. 43).
 - Playback Sound Mode, Tape Speed And Tape Running Displays
 - set "ON SCREEN" to "LCD" or "SIMPLE" in the Menu Screen (☞ pg. 43). Or, press **DISPLAY** on the remote control.
 - The S-Video cable and Audio/Video cable (RCA plug to RCA plug) are optional. Be sure to use the following:
 - S-Video cable: YTU94146A
 - Audio/Video cable (RCA plug to RCA plug): YTU94147A
- Consult the JVC Service Center described on the sheet included in the package for details on their availability. Make sure to connect the ends with a core filter to the camcorder. The core filter reduces interference.
- When editing on a VCR equipped with a DV input connector, an optional DV cable can be connected instead of an S-Video cable and audio/video cable.
 - You can use the AV OUT connector on the camcorder for connection.

CONTINUED ON NEXT PAGE

Program

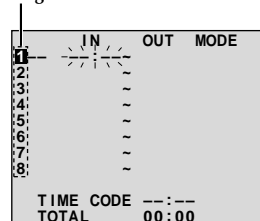
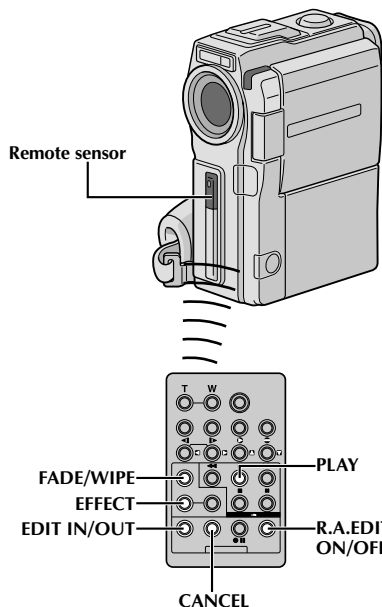
Random Assemble
Editing Menu

SELECT SCENES

- 4 Point the remote control at the camcorder's remote sensor. Press **PLAY** (▶) and then press **R.A.EDIT ON/OFF** on the remote control. The Random Assemble Editing Menu appears.
- 5 If using a Fade/Wipe at the beginning of the scene, press **FADE/WIPE** on the remote control.
 - Cycle through the effects by pressing repeatedly, and stop when the one you want is displayed.
 - You cannot use a Picture Wipe/Dissolve at the beginning of Program 1.
- 6 At the beginning of the scene, press **EDIT IN/OUT** on the remote control. The Edit-In position appears in the Random Assemble Editing Menu.
- 7 At the end of the scene, press **EDIT IN/OUT**. The Edit-Out position appears in the Random Assemble Editing Menu.
- 8 If using a Fade/Wipe at the end of the scene, press **FADE/WIPE**.
 - Cycle through the effects by pressing repeatedly, and stop when the one you want is displayed.
 - If you select a Fade/Wipe effect for an Edit-Out point, the effect is automatically applied to the following Edit-In point.
 - You cannot use a Picture Wipe/Dissolve at the end of the last scene.
 - When you use Fade/Wipe effects, that time is included in the total time (this does not apply to Picture Wipe/Dissolve).
- 9 If using Playback Special Effects, press **EFFECT** (☞ p. 69).
- 10 Repeat steps 6 through 9 to register additional scenes.
 - To change previously registered points, press **CANCEL** on the remote control. The registered points disappear, one at a time, from the most recently registered point.
 - If you are not using Fade/Wipe or Program AE with special effects, repeat steps 6 and 7 only.

NOTES:

- When choosing a scene, set Edit-In and Edit-Out points so that there is a relatively large difference between them.
- If the search time for an in-point exceeds 5 minutes, the recording deck's Record-Standby mode will be canceled and editing will not take place.
- If there are blank portions before or after the Edit-In and Edit-Out points, a blue screen may be included in the edited version.
- Since time codes register time only as accurately as seconds, the time code total time may not match the total program time exactly.
- Turning off the camcorder's power erases all registered Edit-In and Edit-Out points.
- If you select Sepia or Monotone mode from Program AE with special effects, you cannot use the Dissolve or Black & White Fader. In this case the Dissolve or Black & White indicator begins blinking. Once the next Edit-In point is registered, the effect is turned off. To combine these effects, use Sepia or Monotone during recording, then use the Dissolve or Black & White Fader during Random Assemble Editing.
- It is not possible to use Fade/Wipe effects and Program AE with special effects during Random Assemble Editing using a DV cable.

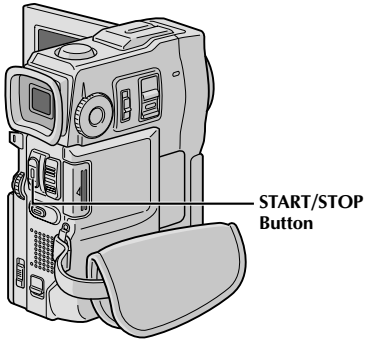
START/STOP
Button

	IN	OUT	MODE
1	00:25	02:05	ⓅP
2	07:18	08:31	
3	03:33	05:53	B/W
4	09:30	13:15	Ⓟ
5	15:55	16:20	
6			
7			
8			
T I M E C O D E		16:30	
T O T A L		9:39	

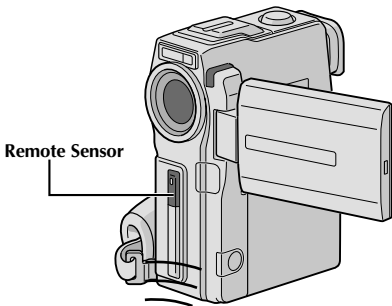
Random Assemble
Editing Menu

Remote Sensor

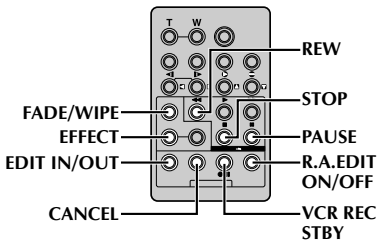

AUTOMATIC EDITING TO VCR

11 Rewind the tape in the camcorder to the beginning of the scene you want to edit and press **PAUSE (II)**.

12 Point the remote control towards the VCR's remote sensor and press **VCR REC STBY (●II)**, or manually engage the VCR's Record-Pause mode.

13 Press **START/STOP** on the camcorder. Editing proceeds as programmed, right through to the end of the last registered scene.

- Pressing **START/STOP** on the remote control does not start editing.
- When dubbing is complete, the camcorder enters the Pause mode, and the VCR enters its Record-Pause mode.
- If you do not register an Edit-Out point, the tape will be dubbed all the way to the end automatically.
- If you operate the camcorder during automatic editing, the VCR will enter its Record-Pause mode and automatic editing will stop.

14 Engage the Stop modes for the camcorder and the VCR.

- To make the R.A.Edit counter display disappear, press **R.A.EDIT ON/OFF** on the remote control.

NOTES:

- Pressing **R.A.EDIT ON/OFF** on the remote control clears all settings registered during Random Assemble Editing.
- When the editing cable is connected to the remote control's Pause In connector during dubbing, make sure the remote control is pointed at the VCR's sensor, and the path between the two is unobstructed.
- Random Assemble Editing may not function properly when using a tape including several duplicated time codes (☞ pg. 23).

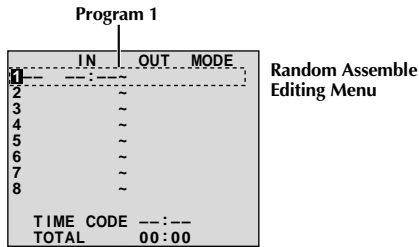

For More Accurate Editing

Some VCRs make the transition from Record-Pause to Record mode faster than others. Even if you begin editing for the camcorder and the VCR at exactly the same time, you may lose scenes you wanted, or find that you have recorded scenes you did not want. For a cleanly edited tape, confirm and adjust the timing of the camcorder against your VCR.

DIAGNOSING VCR/CAMCORDER TIMING

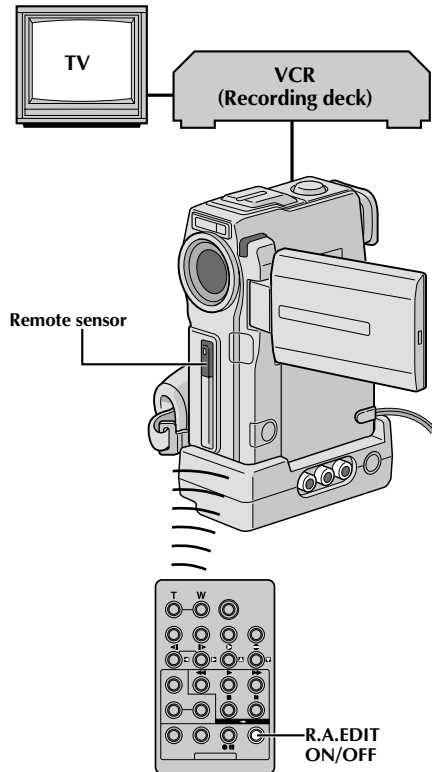

- 1 Play back the tape in the camcorder, then point the remote control at the camcorder's remote sensor and press **R.A.EDIT ON/OFF**. The Random Assemble Editing Menu appears.
- 2 Perform Random Assemble Editing on Program 1 only. In order to check VCR and camcorder timing, select the beginning of a scene transition as your Edit-In point.
- 3 Play back the dubbed scene.
 - If any images from the scene prior to the transition you chose for your Edit-In point were recorded, that means your VCR moves too quickly from Record-Pause to Record mode.
 - If the scene you tried to dub starts in progress, the VCR is slow to start recording.

ADJUSTMENT OF VCR/CAMCORDER TIMING

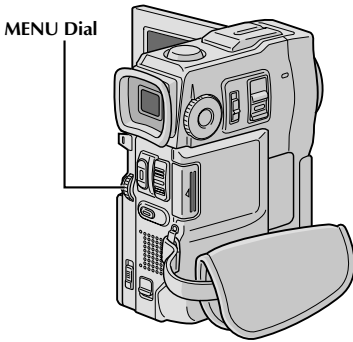

Display

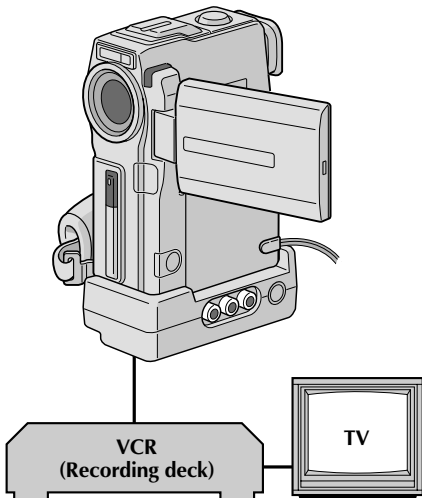

- 4** Point the remote control at the camcorder's remote sensor and press **R.A.EDIT ON/OFF** to make the Random Assemble Editing menu disappear, then press the **MENU** wheel. The Menu Screen appears.
- 5** Rotate the **MENU** wheel to select "**SYNCHRO**" and press it. "VIDEO MENU" appears. Then, rotate it to "SYNCHRO" and press it. The value for "SYNCHRO" is highlighted.
- 6** Based on the diagnostics performed (pg. 74), you can now advance the VCR's record timing by rotating the **MENU** wheel towards "+". You can also delay the VCR's record timing by rotating the **MENU** wheel towards "-". The adjustment range is from -1.3 to +1.3 seconds, in 0.1-second increments. Press the **MENU** wheel to finish the setting.
- 7** Rotate the **MENU** wheel to select "**RETURN**" and press it twice.
Now perform Random Assemble Editing beginning with step 4 on page 72.

NOTES:

- Before performing actual Random Assemble Editing, do a few Random Assemble Editing trial runs to check whether the value you have input is appropriate or not, and make adjustments accordingly.
- Depending on the recorder, there may be situations where the timing difference cannot be fully corrected.

Display

Audio Dub
Standby mode

POWER Switch Lock Button

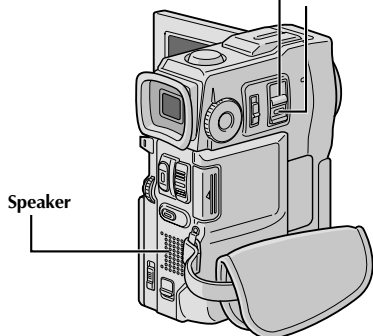

Speaker

Stereo microphone

Remote sensor

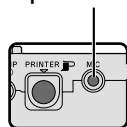
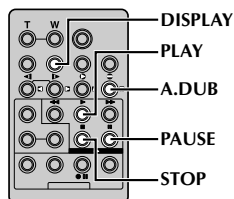
External
microphone
input connectorLocated
beneath
the cover.AV OUT
(headphone)
connector

DISPLAY

PLAY

A.DUB

PAUSE

STOP

Audio Dubbing

The audio track can be customized only when recorded in the 12-bit mode (☞ pg. 29).

NOTES:

- Audio Dubbing is not possible on a tape recorded in 16-bit audio, on a tape recorded in the LP mode or on a blank portion of a tape.
- To perform Audio Dubbing while watching on the television, make connections (☞ pg. 58).

- 1 Play back the tape to locate the point where editing will start, then press **PAUSE (II)**.
- 2 While holding **A.DUB (II)** on the remote control, press **PAUSE (II)**. "II" appears.
- 3 Press **PLAY (▶)**, then begin "narrating".
Speak into the microphone.
• To pause dubbing, press **PAUSE (II)**.
- 4 To end Audio Dubbing, press **PAUSE (II)**, then **STOP (■)**.

To hear the dubbed sound during playback . . .

.... set "12BIT MODE" to "SOUND 2" or "MIX" in the Menu Screen (☞ pg. 43, 44).

NOTES:

- Audio dubbing is also possible using an optional microphone connected to the MIC connector on the Docking Station. The provided Audio cable reduces interference.
- Sound is not heard from the speaker during Audio Dubbing. To hear sound, connect optional headphones to the AV OUT connector.
- **When using an optional microphone or headphones, be sure to connect it to the provided Audio cable with a core filter attached to reduce interference (☞ pg. 7).**
- While an optional microphone is connected, the built-in microphone is disabled.
- When editing onto a tape that was recorded at 12-bit, the old and new soundtracks are recorded separately.
- If you dub onto a blank space on the tape, the sound may be disrupted. Make sure you only edit recorded areas.
- If feedback or howling occurs during TV playback, move the camcorder's microphone away from the TV, or turn down the TV's volume.
- If you change from 12-bit to 16-bit in mid-recording and then use the tape for Audio Dubbing, it is not effective from the point where 16-bit recording began.
- During Audio Dubbing, when the tape moves to scenes recorded in the LP mode, scenes recorded in 16-bit audio or a blank portion, Audio Dubbing stops (☞ pg. 91).

Display

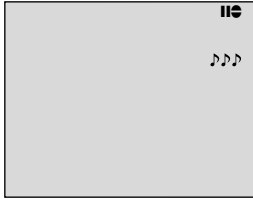
Audio Dub
Standby mode

MENU Wheel

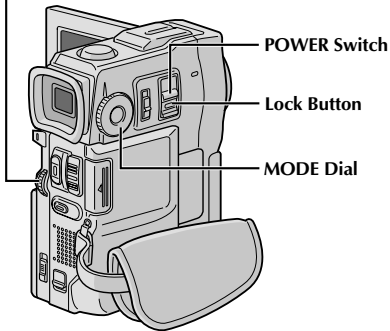

POWER Switch

Lock Button

MODE Dial

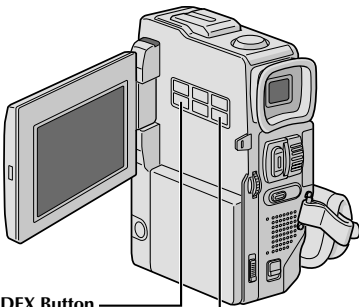

INDEX Button

DIGITAL SOUND Button

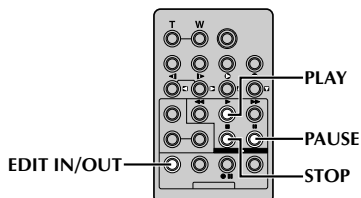

EDIT IN/OUT

PLAY

PAUSE

STOP

Audio Dubbing Using Digital Sound Effects

- 1** Load the provided MultiMediaCard (pg. 14) and perform step 1 and 2 of page 76.
- 2** Press **EDIT IN/OUT** so that “♪♪♪” appears.
 - To select the sound effect, press **INDEX** to display the **SOUND Index Screen** (pg. 49), then use the **MENU** wheel to select the desired sound effect.
 - If no Digital Sound Effect is displayed the microphone input will be dubbed onto the tape.
- 3** Press **PLAY** (▶) to begin Audio Dubbing.
- 4** Press **DIGITAL SOUND** where you want to use the sound effect.
 - The displayed sound effect blinks while it is being dubbed.
 - To stop dubbing the sound effect midway, press **DIGITAL SOUND** again.
- 5** Press **STOP** (■) to end Audio Dubbing.

NOTES:

- The dubbed sound effect is recorded on **SOUND 2** (pg. 44).
- If you press **PAUSE** (||) to pause dubbing in step 4 the selected sound effect indication remains displayed.
- If you press **STOP** (■) to end Audio Dubbing in step 5 the selected sound effect continues to be heard from the connected headphones (optional); press **DIGITAL SOUND** to stop the sound effect.

After Use

- 1 Turn off the camcorder.
- 2 Slide down and hold **OPEN/EJECT** in the direction of the arrow, then pull the cassette holder cover open until it locks. The cassette holder opens automatically. Remove the cassette.
- 3 Press "PUSH HERE" to close the cassette holder.
 - Once the cassette holder is closed, it recedes automatically. Wait until it recedes completely before closing the cassette holder cover.
- 4 Open the card cover, then press **EJECT**. The MultiMediaCard is disengaged from the camcorder. Remove the MultiMediaCard.
- 5 Close the card cover.
- 6 Slide down **BATT. RELEASE** ① and remove the battery pack ②③.

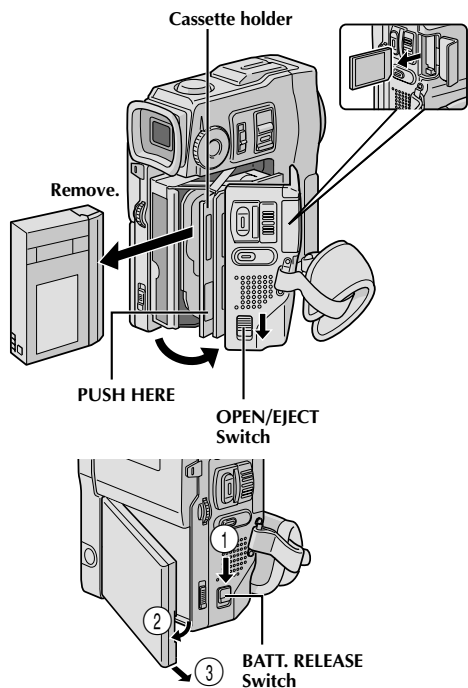

Cleaning The Camcorder

- 1 To clean the exterior, wipe gently with a soft cloth. Put the cloth in diluted mild soap and wring it well to wipe off heavy dirt. Then wipe again with a dry cloth.
- 2 Open the LCD monitor. Wipe gently with a soft cloth. Be careful not to damage the monitor. Close the LCD monitor.
- 3 To clean the lens, blow it with a blower brush, then wipe gently with lens cleaning paper.
- 4 Pull out the viewfinder fully.
- 5 Open the viewfinder cleaning hatch in the direction of the arrow ①. Insert a lens blower or soft cloth into the gap at the side of the viewfinder and clean the interior of the viewfinder with it ②.
- 6 Close the hatch until it locks in place and push the viewfinder back in.

NOTES:



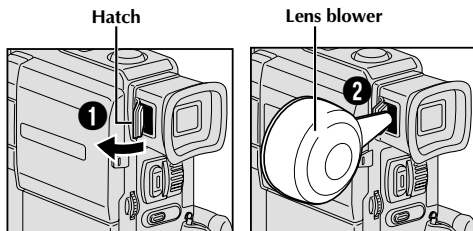

- Avoid using strong cleaning agents such as benzine or alcohol.
- Cleaning should be done only after the battery pack has been removed or other power units have been disconnected.
- Mold may form if the lens is left dirty.
- When using a cleaner or chemically treated cloth refer to the cautions of each product.



If, after following the steps in the chart below, the problem still exists, please consult your nearest JVC dealer.

The camcorder is a microcomputer-controlled device. External noise and interference (from a TV, a radio, etc.) might prevent it from functioning properly. In such cases, first disconnect its power supply unit (battery pack, AC Power Adapter/Battery Charger, etc.) and wait a few minutes; and then re-connect it and proceed as usual from the beginning.

SYMPTOM	POSSIBLE CAUSES	CORRECTIVE ACTION
1. No power is supplied.	1. • The power is not connected properly. • The battery is dead. • The LCD monitor is not open fully or the viewfinder is not pulled out when recording.	1. • Connect the AC Power Adapter/Charger securely (☞ pg. 9). • Replace the dead battery with a fully charged one (☞ pg. 8, 9). • Open the LCD monitor fully or pull out the viewfinder.
2. "SET DATE/TIME!" appears.	2. • The built-in clock's rechargeable lithium battery is discharged. • The previously set date/time is erased.	2. • Connect the camcorder to an AC outlet using the AC Power Adapter/Charger for over 24 hours to charge the clock's lithium battery (☞ pg. 11).
3. Recording cannot be performed.	3. • The tape's erase protection tab is set to "SAVE". • The POWER Switch is set to "PLAY/PC", "MEMORY" or "OFF". • "TAPE END" appears. • The cassette holder cover is open.	3. • Set the tape's erase protection tab to "REC" (☞ pg. 12). • Set the POWER Switch to "CAMERA" (☞ pg. 16). • Replace with new cassette (☞ pg. 12). • Close the cassette holder cover.
4. There is no picture.	4. • The camcorder is not getting power, or some other malfunction exists.	4. • Turn the camcorder's power off and on again (☞ pg. 18).
5. Some functions are not available using the MENU wheel.	5. • The Operation Switch is set to "A".	5. • Set the Operation Switch to "M" (☞ pg. 16).
6. The focus does not adjust automatically.	6. • Focus is set to the Manual mode. • The recording was done in a dark place, or the contrast was low. • The lens is dirty or covered with condensation.	6. • Set Focus to the Auto mode (☞ pg. 27). • Clean the lens and check the focus again (☞ pg. 78).
7. The cassette will not load properly.	7. • The cassette is in the wrong position. • The battery's charge is low.	7. • Set it in the right position (☞ pg. 12). • Install a fully charged battery (☞ pg. 8, 9).
8. The MultiMediaCard will not load properly.	8. • The MultiMediaCard is in the wrong position.	8. • Set it in the right position (☞ pg. 14).
9. In the 5-Second mode, recording ends before 5 seconds have elapsed.	9. • The 5-Second mode is set to "ANIM." in the Menu Screen.	9. • Select "5S" in the Menu Screen (☞ pg. 35).
10. Snapshot mode cannot be used.	10. • The Squeeze mode is selected.	10. • Disengage the Squeeze mode (☞ pg. 30).

SYMPTOM	POSSIBLE CAUSES	CORRECTIVE ACTION
11. The color of Snapshot looks strange.	11. • The light source or the subject does not include white. Or there are various different light sources behind the subject. • The Sepia or Monotone mode is activated.	11. • Set "FLASH" to "ON" in the Menu Screen. Or find a white subject and compose your shot so that it also appears in the frame (☞ pg. 20, 21, 32). • Turn off Sepia and Monotone (☞ pg. 38).
12. Although Snapshot is attempted, flash does not take place.	12. • The subject is too bright with the flash set to "AUTO" or "AUTO  ". • If  blinks, the flash is being charged. • The camcorder is in the Record mode. • In the Menu Screen, "GAIN UP" is set to "OFF" or "PAE/EFFECT" is set to "TWILIGHT".	12. • Set "FLASH" to "ON" in the Menu Screen (☞ pg. 32). • It can take up to 10 seconds to charge the flash. • Set the camcorder in the Record-Standby mode (☞ pg. 32). • Set "GAIN UP" to "AUTO  " or "AGC" (☞ pg. 29) or disengage the "TWILIGHT" mode (☞ pg. 38).
13. Although a Snapshot is taken with the flash, Red-Eye Reduction does not take place.	13. • The subject does not look straight toward the flash. • The subject does not look at the first flash, which is an important part of Red-Eye Reduction. • The camcorder is too far from the subject. • "FLASH" is not set to "AUTO  " in the Menu Screen.	13. • The subject should look straight toward the flash, especially the first flash. If the subject does not see the first flash, it will be difficult for Red-Eye Reduction to take place (☞ pg. 32). • The flash is effective for subjects at a distance of approx. 0.7 m/27-9/16" to 2 m/6.5 ft from the camcorder (☞ pg. 32). • Set "FLASH" to "AUTO  " in the Menu Screen to display the Red-Eye Reduction indicator (☞ pg. 32).
14. The image taken using Snapshot is too dark.	14. • "FLASH" is set to "OFF" in the Menu Screen. • The flash emission window is covered by fingers, etc.. • The flash brightness is set to produce a darker image (adjustment value: -3). • The camcorder is too far from the subject. • Shooting was performed under backlit conditions.	14. • Set "FLASH" to any position except "OFF" in the Menu Screen (☞ pg. 32). • Do not cover the flash emission window. • Adjust the flash brightness to a larger value (☞ pg. 33). • The flash is effective for subjects at a distance of approx. 0.7 m/27-9/16" to 2 m/6.5 ft (☞ pg. 32). • Press the BACKLIGHT Button (☞ pg. 40).
15. The image taken using Snapshot is too bright.	15. • "FLASH" is set to "ON" in the Menu Screen.	15. • Set "FLASH" to any parameter other than "ON" in the Menu Screen (☞ pg. 32).
16. Digital Zoom does not work.	16. • 10X optical zoom is selected. • The MODE Dial is set to " DUAL " or " DSC ". • "PAE/EFFECT" is set to "VIDEO ECHO" in the Menu Screen. • "WIDE MODE" is set to "PS-WIDE" in the Menu Screen. • Picture Wipe or Dissolve are being used in a scene transition.	16. • Set "ZOOM" to "40X" or "200X" in the Menu Screen (☞ pg. 29). • Set the MODE Dial to " PS " or "VIDEO" (☞ pg. 17, 22). • Disengage the "VIDEO ECHO" mode (☞ pg. 22, 38). • Disengage the "PS-WIDE" mode (☞ pg. 34). • Wait until the Picture Wipe or Dissolve effects are completed (☞ pg. 22, 36).

SYMPTOM	POSSIBLE CAUSES	CORRECTIVE ACTION
17. Program AE with special effects and Fade/Wipe Effects do not work.	17. • The Operation Switch is set to "A".	17. • Set the Operation Switch to "M" (☞ pg. 36, 38).
18. The Black & White Fader does not work.	18. • The Sepia or Monotone mode is activated.	18. • Turn off Sepia and Monotone (☞ pg. 36, 38).
19. The Dissolve function does not work.	19. • The Sepia, Monotone or Slow Shutter mode of Program AE with special effects is activated. • "WIDE MODE" is set to "SQUEEZE" or "PS-WIDE" in the Menu Screen. • The previously selected mode of Program AE with special effects was changed after the last selected scene for editing was registered.	19. • Turn off Sepia, Monotone or Slow Shutter before adding Dissolve to a scene transition (☞ pg. 36, 38). • Set "WIDE MODE" to "CINEMA" or "OFF" mode (☞ pg. 30). • Make sure you have selected the mode of Program AE with special effects you want before starting editing (☞ pg. 36, 38).
20. The Picture Wipe and Dissolve functions do not work.	20. • The last selected editing scene is ending. • At the end of the last selected scene for editing, the POWER Switch was set to "OFF". • The power is off.	20. • Select Picture Wipe or Dissolve before beginning recording. The effects are then automatically activated (☞ pg. 36). • Do not turn off the camcorder's power after setting Edit-In and Edit-Out points, as they will all be erased (☞ pg. 36). • The camcorder automatically shuts off after 5 minutes have elapsed in the Record-Standby mode. Make sure you continue operations within 5 minutes after engaging Record-Standby mode (☞ pg. 36).
21. The picture wipe function does not work.	21. • The Slow Shutter mode is activated. • "WIDE MODE" is not set to "OFF".	21. • Disengage the Slow Shutter mode or set "WIDE MODE" to "OFF" before preparing to use the Picture Wipe (☞ pg. 30, 36, 38).
22. Scene transition does not go as expected.	22. • When using "Picture Wipe/Dissolve" (☞ pg. 36), there is a delay of a fraction of a second between the previous record stop-point and the Dissolve start-point. This is normal, but this slight delay becomes especially noticeable when shooting fast-moving subject or during rapid panning.	22. <hr style="width: 10%; margin: auto;"/>
23. The Video Echo mode does not work.	23. • The Picture Wipe or Dissolve functions are in use. • "WIDE MODE" is set to "SQUEEZE" or "PS-WIDE" in the Menu Screen. • A Fade-In or Fade-Out is in progress.	23. • Set "WIDE MODE" to "CINEMA" or "OFF" mode (☞ pg. 30). • Do not try to use the Video Echo mode during a Fade-In or Fade-Out (☞ pg. 36, 38).

CONTINUED ON NEXT PAGE

SYMPTOM	POSSIBLE CAUSES	CORRECTIVE ACTION
24. Even when Slow Shutter is not selected, the image looks like it is activated.	24. • When shooting in the dark, the unit becomes highly sensitive to light and the image takes on an effect similar to Slow Shutter.	24. • If you want the lighting to look more natural, set GAIN UP to "AGC" or "OFF" in the Menu Screen (☞ pg. 29).
25. There is no strobe when the Classic Film or Strobe mode is activated.	25. • The Picture Wipe or Dissolve function is in use.	25. • Do not try to use the Classic Film or Strobe mode during a scene transition (☞ pg. 36, 38).
26. White Balance cannot be activated.	26. • The Sepia or Monotone mode is activated.	26. • Turn off Sepia or Monotone before setting White Balance (☞ pg. 38, 41).
27. When shooting a subject illuminated by bright light, vertical lines appear.	27. • This is a result of exceedingly high contrast, and is not a malfunction.	27. _____
28. When the screen is under direct sunlight during shooting, the screen becomes red or black for an instant.	28. • This is not a malfunction.	28. _____
29. During recording, the date/time does not appear.	29. • "DATE/TIME" is set to "OFF" in the Menu Screen. • Self-Recording is performed.	29. • Set "DATE/TIME" to "ON" in the Menu Screen (☞ pg. 31). • During Self-Recording, the date/time does not appear (☞ pg. 19).
30. Files stored in the MultiMediaCard cannot be deleted.	30. • Files stored in the MultiMediaCard are protected.	30. • Remove protection from the files stored in the MultiMediaCard and delete them (☞ pg. 50, 51).
31. The indicators and messages do not appear.	31. • "ON SCREEN" is set to "SIMPLE" or "TIME CODE" is set to "OFF" in the Menu Screen.	31. • Set "ON SCREEN" to "LCD" or "LCD/TV" and set "TIME CODE" to "ON" in the Menu Screen (☞ pg. 31, 43).
32. Images on the LCD monitor appear dark or whitish.	32. • In places subject to low temperature, images become dark due to the characteristics of the LCD monitor. When this happens, the displayed colors differ from those that are actually recorded. This is not a defect of the camcorder. • When the LCD monitor's fluorescent light reaches the end of its service life, images on the LCD monitor become dark. Consult your nearest JVC dealer.	32. • Adjust the brightness and angle of the LCD monitor (☞ pg. 18, 19).
33. The rear of the LCD monitor is hot.	33. • The light used to illuminate the LCD monitor causes it to become hot.	33. • Close the LCD monitor to turn it off or set the POWER Switch to "OFF", and let the unit cool down.
34. The indicators and the image color on the LCD monitor are not clear.	34. • This may occur when the surface or the edge of the LCD monitor is pressed.	34. _____

SYMPTOM	POSSIBLE CAUSES	CORRECTIVE ACTION
35. The LCD monitor or viewfinder indications blink.	35. • Certain Fade/Wipe effects, certain modes of Program AE with special effects, "DIS" and other functions that cannot be used together are selected at the same time.	35. • Re-read the sections covering Fade/Wipe effects, Program AE with special effects and "DIS" (☞ pg. 30, 36 – 38).
36. Colored bright spots appear all over the LCD monitor or the viewfinder.	36. • The LCD monitor and the viewfinder are made with high-precision technology. However, black spots or bright spots of light (red, green or blue) may appear constantly on the LCD monitor or the viewfinder. These spots are not recorded on the tape. This is not due to any defect of the unit. (Effective dots: more than 99.99 %)	36. _____
37. During recording, sound cannot be heard.	37. • The optional headphones are not connected to the headphones connector. • The sound volume of the headphones connector was not adjusted appropriately. The sound volume at this point is the same as the level it was adjusted to during playback.	37. • Connect the optional headphones to the headphone connector (☞ pg. 86, 87). • Adjust the sound volume during playback (☞ pg. 42).
38. Play, Rewind and Fast-Forward functions do not work.	38. • The POWER Switch is not set to "PLAY/PC".	38. • Set the POWER Switch to "PLAY/PC" (☞ pg. 42).
39. A MultiMediaCard cannot be played back.	39. • The POWER Switch is set to "CAMERA" or "PLAY/PC".	39. • Set the POWER Switch to "MEMORY PLAY" (☞ pg. 47).
40. The tape is moving, but there is no picture.	40. • Your TV has AV input terminals, but is not set to its VIDEO mode. • The cassette holder cover is open.	40. • Set the TV to the mode or channel appropriate for video playback (☞ pg. 58, 59). • Close the cassette holder cover (☞ pg. 12).
41. The LCD monitor image is distorted.	41. • During playback of the unrecorded portion, High-speed Search and still playback, LCD monitor indications appear distorted. This is not a defect.	41. _____
42. Images on the LCD monitor are jittery.	42. • The speaker volume is too great.	42. • Turn the speaker volume down (☞ pg. 42).
43. Blocks of noise appear during playback, or there is no playback picture and the screen becomes blue.	43. _____	43. • Clean the video heads with an optional cleaning cassette (☞ pg. 94).
44. The LCD monitor, the viewfinder and the lens have become dirty (ex. fingerprints).	44. _____	44. • Wipe them gently with soft cloth. Wiping strongly can cause damage (☞ pg. 78).

SYMPTOM	POSSIBLE CAUSES	CORRECTIVE ACTION
45. An unusual mark appears.	45. _____	45. • Check the section of the manual that explains LCD monitor/viewfinder indications (☞ pg. 88 – 92).
46. An error indication (E01 — E06) appears.	46. • A malfunction of some kind has occurred. In this case the camcorder's functions become unusable.	46. • Remove the power supply (battery pack, etc.) and wait a few minutes for the indication to clear. When it does, you can resume using the camcorder. If the indication remains even though you repeat the above two or three times, please consult your nearest JVC dealer.
47. The charger indicator on the AC Power Adapter/Charger does not light.	47. • The temperature of the battery is extremely high/low. • Charging is difficult in places subject to extremely high/low temperatures.	47. • To protect the battery, it is recommended to charge it in places with a temperature of 10°C to 35°C (50°F to 95°F) (☞ pg. 93).
48. Picture does not appear on the LCD monitor.	48. • The viewfinder is pulled out. • The LCD monitor's brightness setting is too dark.	48. • Push the viewfinder back in. • Adjust the brightness of the LCD monitor (☞ pg. 18). • If the monitor is tilted upward 180 degrees, open the monitor fully (☞ pg. 18).
49. When the image is printed from the printer, a black bar appears at the bottom of the screen.	49. • This is not a malfunction.	49. • By recording with "DIS" activated (☞ pg. 30) this can be avoided.
50. When the camcorder is connected via the DV connector, the camcorder does not operate.	50. • The DV cable was plugged/unplugged with power turned on.	50. • Turn the camcorder's power off and on again, then operate it.
51. During transport, the lens cover opens.	51. _____	51. • Do not subject the camcorder to shock or excessive vibration during transport. • Turn the camcorder on and off. The lens cover closes.
52. The MultiMediaCard cannot be removed from the camcorder.	52. _____	52. • Push in the MultiMediaCard a few more times (☞ pg. 14).

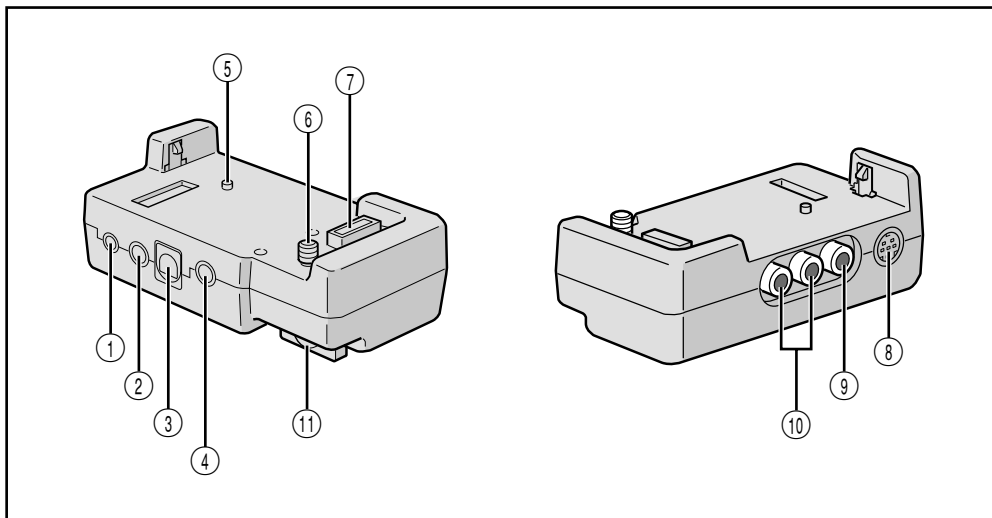

① PC Connector [DIGITAL STILL] pg. 60

② J Terminal/Edit Connector [JLIP (Joint Level Interface Protocol) (EDIT)] pg. 61

- Connect to a JLIP-compatible camcorder or VCR to control it from the computer using the provided Software.

NOTE:

Make sure that the camcorder is turned on while connecting the camcorder to a PC using the Docking Station's JLIP connector. If the camcorder is turned off (because the **POWER** Switch is set to "OFF" or due to Auto Shut Off* etc.) while the JLIP program software is used, it will be impossible to control the connected devices from the computer. In such a case, first try turning the camcorder on again, or unplug the JLIP connection cable from the Docking Station's JLIP connector. Then, initialize or run the software again.

* **Auto Shut Off:**

If 5 minutes elapse in the Record-Standby mode or in the Pause mode, the camcorder's power shuts off automatically to conserve energy.

- Connect the editing cable when performing Random Assemble Editing pg. 70 – 75.

③ PRINTER Connector

Connect to the optional printer equipped with a PRINT DATA connector. Refer to the separate "FOR OWNERS OF AN OPTIONAL PRINTER" instruction sheet.

④ External Stereo Microphone Input Connector [MIC] pg. 76

⑤ Stud pg. 58

⑥ Screw pg. 58

⑦ Multi Connector

The Docking Station can be connected with this camcorder through this connector. Never touch it with your hand or hit it with a hard object; if the pins are damaged, the connectors will become unusable due to contact failure.

⑧ S-Video Output Connector [S OUT] pg. 58, 71

⑨ Video Output Connector [VIDEO] pg. 58, 71







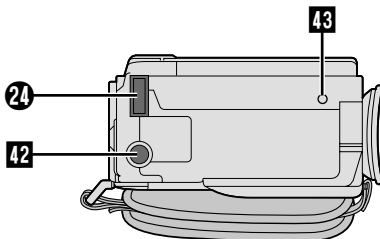
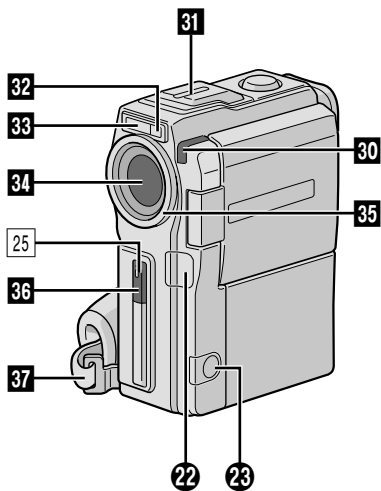
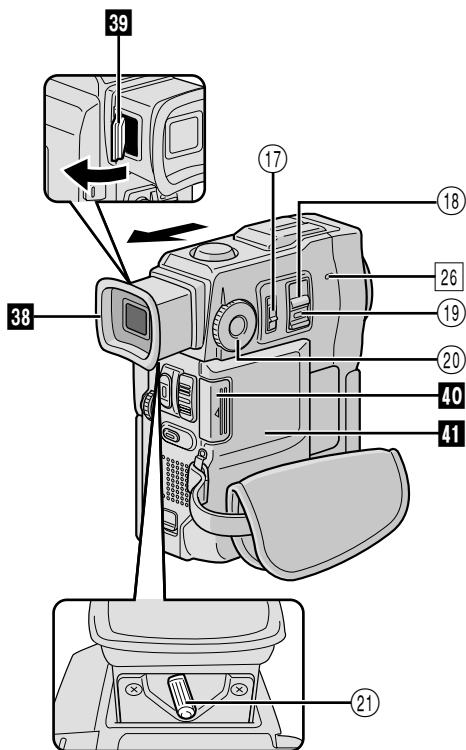
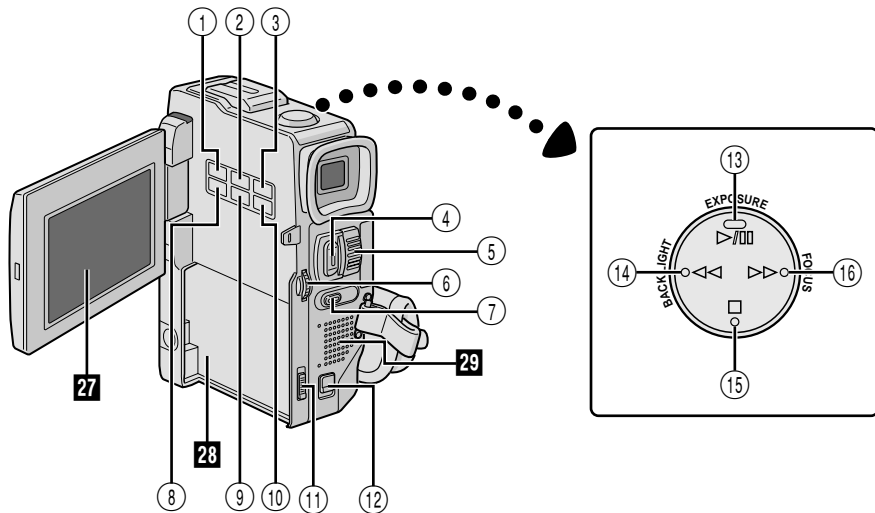

















⑩ Audio Output Connectors [AUDIO L/R] pg. 58, 71

⑪ Screw Knob pg. 58

To attach the camcorder, tighten this clockwise.







Controls



- ① PRINT Button
Enables printing using the optional printer equipped with a PRINT DATA connector. Refer to the separate "FOR OWNERS OF AN OPTIONAL PRINTER" instruction sheet.
- ② PRINT FRAME Button  pg. 53
- ③ E-MAIL CLIP REC Button  pg. 46
- ④ START/STOP Button  pg. 18
- ⑤ • Power Zoom Lever [T/W]  pg. 22
• Speaker/Headphone Volume Control [VOL.]  pg. 42
- ⑥ • MENU Wheel [+ , - , ▶]  pg. 28
• LCD Monitor Brightness Control [+ , -]  pg. 18
- ⑦ Snapshot Button [SNAPSHOT]  pg. 20, 21, 24, 26, 65
- ⑧ INDEX Button  pg. 39, 48, 49
- ⑨ IMAGE SIZE/RES. Button  pg. 15
- ⑩ DIGITAL SOUND Button  pg. 39, 77
- ⑪ Battery Release Switch [BATT. RELEASE]  pg. 9
- ⑫ OPEN/EJECT Switch  pg. 12
- ⑬ • Play/Pause Button [▶/⏸]  pg. 42
• EXPOSURE Button  pg. 40
- ⑭ • Rewind Button [◀◀]  pg. 42
• BACKLIGHT Button  pg. 40
- ⑮ Stop Button [■]  pg. 42
- ⑯ • Fast-Forward Button [▶▶]  pg. 42
• FOCUS Button  pg. 27
- ⑰ Operation Switch [A , M]  pg. 16
- ⑱ POWER Switch [CAMERA , PLAY/PC , MEMORY PLAY , OFF]  pg. 16
- ⑲ Lock Button  pg. 16
- ⑳ MODE Dial [PS , VIDEO , DUAL , DSC]  pg. 17
- ㉑ Diopter Adjustment Control  pg. 10

Connectors













The connectors ㉒ to ㉔ are located beneath a cover.

- ㉒ Digital Video Connector [DV IN/OUT] (i.link*)  pg. 60, 61, 63
* i.Link refers to the IEEE1394-1995 industry specification and extensions thereof. The  logo is used for products compliant with the i.Link standard.
- ㉓ • Audio/Video Output Connector [AV OUT]  pg. 58
• Headphone Connector [Ω]  pg. 76
- ㉔ Multi Connector
When attached to the Docking Station, this part is connected.

Indicators

- ㉕ Tally Lamp  pg. 18
- ㉖ POWER Lamp  pg. 18

Other Parts

- ㉗ LCD Monitor  pg. 18, 19
- ㉘ Battery Pack Mount  pg. 9
- ㉙ Speaker  pg. 42
- ㉚ Camera Sensor
Be careful not to cover this area, a sensor necessary for shooting is built-in here.
- ㉛ Stereo Microphone  pg. 76
- ㉜ Flash Sensor
Be careful not to cover this area, as it contains a sensor required by the flash.
- ㉝ Flash  pg. 32
- ㉞ Lens
- ㉟ Lens Protector
When using an optional lens filter (commercially available), you must first detach the lens cover.
- ㊱ Remote Sensor  pg. 66
- ㊲ Grip Strap  pg. 10
- ㊳ Viewfinder  pg. 10
- ㊴ Viewfinder Cleaning Hatch  pg. 78
- ㊵ Memory Card Cover  pg. 14
- ㊶ Cassette Holder Cover  pg. 12
- ㊷ Tripod Mounting Socket  pg. 10
- ㊸ Stud Hole  pg. 58

LCD Monitor/Viewfinder Indications During Video Recording Only

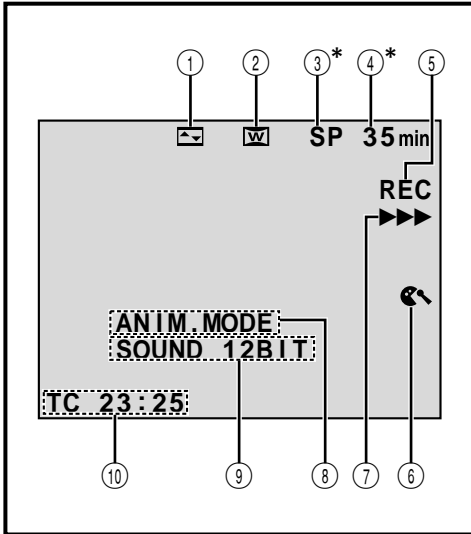

- ① Displays the selected Fade/Wipe effect. (☞ pg. 36, 37)
- ② Appears when in the Squeeze, Cinema or PS Wide mode. (☞ pg. 30)
- ③* Displays the recording mode (SP or LP). (☞ pg. 13)
- ④* Displays the tape remaining time. (☞ pg. 18)
- ⑤
 - “REC” appears during recording.
 - “PAUSE” appears during Record-Standby mode. (☞ pg. 18)
- ⑥ Appears when the wind cut mode is engaged to cut down on noise created by wind. (☞ pg. 31)
- ⑦ Appears while the tape is running. (☞ pg. 18)
- ⑧ 5S MODE/ANIM. MODE: Displays the 5 second recording mode or Animation recording mode. (☞ pg. 30, 35)
- ⑨ Displays the sound mode for approx. 5 seconds after turning on the camcorder. (☞ pg. 29)
- ⑩ Displays the Time Code. (☞ pg. 23, 31)

*Setting “ON SCREEN” to “SIMPLE” in the Menu Screen removes indications marked with * from the screen (☞ pg. 31, 43).

LCD Monitor/Viewfinder Indications During D.S.C. Recording Only

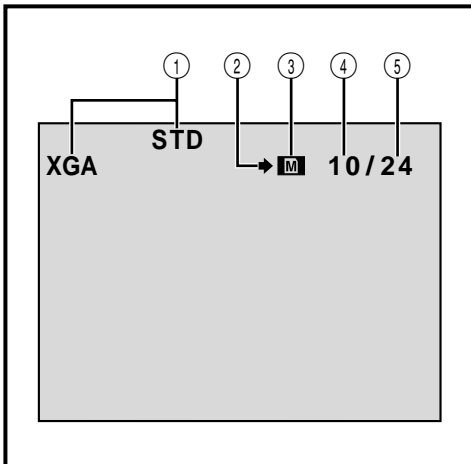

- ① Displays the Picture Quality/Size mode of the stored image. There are 4 modes available: XGA FINE, XGA STD, VGA FINE and VGA STD (in order of quality). (☞ pg. 15)
- ② Appears and blinks during shooting. (☞ pg. 21)
- ③
 - Appears during shooting.
 - Blinks when a MultiMediaCard is not loaded. (☞ pg. 21)
- ④ Displays the number of images that have already been shot. (☞ pg. 21)
- ⑤ Displays the total number of shots that can be stored, including those already taken. (☞ pg. 21)

These indications also appear during DUAL mode.

LCD Monitor/Viewfinder Indications During Both Video And D.S.C. Recording

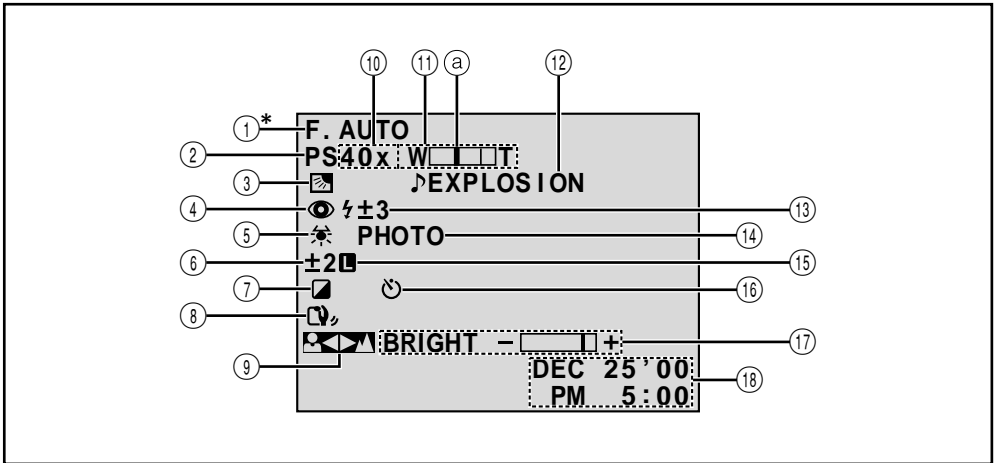

- ①* Appears when the Operation switch is set to "A". (☞ pg. 16)
- ② Displays the shooting mode position. (☞ pg. 17)
- ③ Appears when backlight compensation is used. (☞ pg. 40)
- ④ Appears when "FLASH" is set to "AUTO" in the Menu Screen. (☞ pg. 32)
- ⑤ Appears when the white balance is adjusted. (☞ pg. 41)
- ⑥ Appears when the exposure is adjusted. (☞ pg. 40)
- ⑦ Displays the selected Program AE with special effects. (☞ pg. 38)
- ⑧ Appears when Digital Image Stabilizer ("DIS") is engaged. (☞ pg. 30)
- ⑨ Appears when the focus is adjusted manually. (☞ pg. 27)
- ⑩
- Approximate zoom ratio: Appears during zooming. (☞ pg. 22)
 - $\mathbf{A} \pm 3$: Appears when "GAIN UP" is set to "AUTO" and the shutter speed is automatically adjusted. (☞ pg. 29)
- ⑪ Appears during zooming.
- ⓐ Zoom level indicator (☞ pg. 22)
- ⑫ Displays the selected Digital Sound Effect. (☞ pg. 39)
- ⑬ Appears when the flash is ready. A number appears next to the indication after adjusting the brightness of the flash. (☞ pg. 32, 33)
- ⑭ Appears when taking a Snapshot. (☞ pg. 20, 21)
- ⑮ Appears when the iris is locked. (☞ pg. 40)
- ⑯ Appears during Self-Timer recording. (☞ pg. 34)
- ⑰ Displays the brightness of the LCD monitor or the viewfinder. (☞ pg. 18)
- ⑱ Displays the date/time. (☞ pg. 11)

* Setting "ON SCREEN" to "SIMPLE" in the Menu Screen removes indications marked with * from the screen (☞ pg. 31, 43).

LCD Monitor/Viewfinder Indications During Video Playback

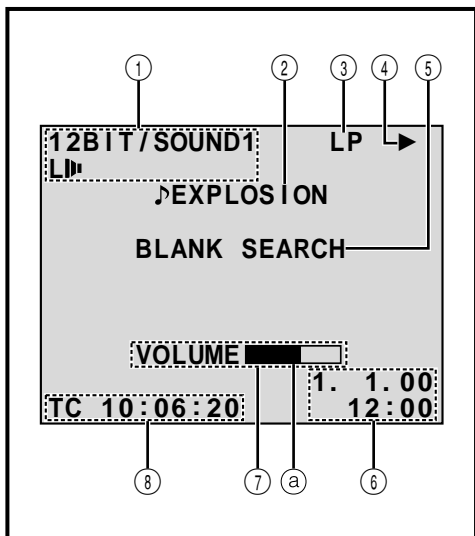





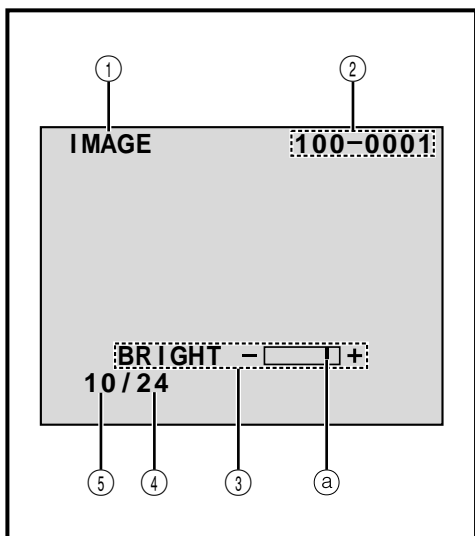





- ① Displays the sound mode. (☞ pg. 43, 44)
- ② Displays the selected Digital Sound Effect. (☞ pg. 39)
- ③ Displays the tape speed. (☞ pg. 13)
- ④ Appears while a tape is running.
 - ▶ : Playback
 - ▶▶ : Fast-Forward/Shuttle search
 - ◀◀ : Rewind/Shuttle search
 - || : Pause
 - ||▶ : Forward slow-motion
 - ◀|| : Reverse slow-motion
 - : Audio Dubbing
 - ||● : Audio Dubbing Pause
- ⑤ Displays the Blank Search mode. (☞ pg. 45)
- ⑥ Displays the date/time. (☞ pg. 43, 44)
- ⑦ BRIGHT : Displays the brightness of the LCD monitor or the viewfinder. (☞ pg. 18)
VOLUME : Displays the speaker or headphone volume. (☞ pg. 42)
 - ⓐ The level indicator moves.
- ⑧ Displays the time code. (☞ pg. 43, 44)

LCD Monitor/Viewfinder Indications During D.S.C. Playback



- ① Displays the type of file (IMAGE/E-MAIL CLIP/SOUND).
- ② Displays the directory and file names. (☞ pg. 47)
- ③ Displays the brightness of the LCD monitor or the viewfinder. (☞ pg. 18)
 - ⓐ The level indicator moves.
- ④ Displays the total number of stored files. (☞ pg. 47)
- ⑤ Displays the index number of the file. (☞ pg. 47)

Warning Indications

Indications	Function
	<p>Displays the battery remaining power. Remaining power level: high  →  →  →  Remaining power level: exhausted  </p> <p>As the battery power comes close to nil, the battery indicator  blinks. When the battery power is exhausted, power turns off automatically.</p>
	<p>Appears when no tape is loaded. (pg. 12)</p>
<p>CHECK TAPE'S ERASE PROTECTION SWITCH</p>	<p>Appears when the erase protection tab is set to "SAVE" while the POWER Switch is set to "CAMERA". (pg. 12)</p>
<p> HEAD CLEANING REQUIRED USE CLEANING CASSETTE</p>	<p>Appears if dirt is detected on the heads during recording. Use an optional cleaning cassette. (pg. 94)</p>
<p> CONDENSATION OPERATION PAUSED PLEASE WAIT</p>	<p>Appears if condensation occurs. When this indication is displayed, wait more than 1 hour until condensation disappears.</p>
<p>TAPE!</p>	<p>Appears if a tape is not loaded when START/STOP is pressed while the POWER Switch is set to "CAMERA" and the MODE Dial is set to "VIDEO", "PS" or "DUAL".</p>
<p>TAPE END</p>	<p>Appears when the tape ends during recording or playback. (pg. 19)</p>
<p>DIFFERENT FORMATTED TAPE</p>	<p>Appears if a tape in another format is loaded.</p>
<p>SET DATE/TIME!</p>	<ul style="list-style-type: none"> ● Appears when the date/time is not set. (pg. 11) ● Appears when the built-in clock (lithium) battery is discharged and the previously set date/time is erased. (pg. 11)
<p>A. DUB ERROR!</p>	<p>Appears if Audio Dubbing is attempted on a blank portion of a tape. (pg. 76)</p>
<p>A. DUB ERROR! <CANNOT DUB ON A LP RECORDED TAPE> <CANNOT DUB ON A 16BIT RECORDING> <CHECK TAPE'S ERASE PROTECTION SWITCH></p>	<ul style="list-style-type: none"> ● Appears if Audio Dubbing is attempted on a tape recorded in the LP mode. (pg. 76) ● Appears if Audio Dubbing is attempted on a tape recorded in 16-bit audio. (pg. 76) ● Appears if A. DUB (⊖) on the remote control is pressed when the erase protection tab is set to "SAVE". (pg. 76)
<p>MEMORY IS FULL</p>	<p>Appears when the MultiMediaCard's memory is full and shooting is not possible.</p>

CONTINUED ON NEXT PAGE

Indications	Function
COPYING FAILED	<ul style="list-style-type: none"> ● Appears if dubbing of copyguarded signals is attempted while this camcorder is being used as a recorder. ● Appears in the following cases when dubbing from a tape to a MultiMediaCard (as digital stills or video clips): <ul style="list-style-type: none"> – when no MultiMediaCard is loaded. – when the MultiMediaCard's memory is full. – when the MultiMediaCard is not formatted. ● Appears in the following cases when dubbing still images or sound effects stored in the MultiMediaCard's memory to a tape: <ul style="list-style-type: none"> – when condensation occurs. – when no tape is loaded. – when the erase protection tab is set to "SAVE". – when a tape in another format is loaded. – when the tape ends. <p style="text-align: right;">(📖 pg. 64)</p>
MEMORY CARD!	<p>Appears if a MultiMediaCard is not loaded when SNAPSHOT is pressed while the POWER Switch is set to "CAMERA" and the MODE Dial is set to "DSC" or "DUAL".</p>
PLEASE FORMAT	<p>Appears when there is a problem with a MultiMediaCard and its memory is corrupt, or it has not been initialized. Initialize the MultiMediaCard.</p> <p style="text-align: right;">(📖 pg. 52)</p>
NO STORED DATA	<p>Appears when the POWER Switch is set to "MEMORY PLAY" and there are no files stored in the MultiMediaCard.</p>
NO SOUND DATA	<p>Appears if there are no sound files stored in the MultiMediaCard when DIGITAL SOUND is pressed.</p>
NO STORED IMAGE	<p>Appears when the POWER switch is set to "MEMORY PLAY" and all image files are deleted.</p>
NO E-CLIP DATA	<p>Appears when the POWER switch is set to "MEMORY PLAY" and all E-clip recording files are deleted.</p>
UNSUPPORTED DATA	<p>Appears when a file in a format other than MP3 is selected.</p>
E01 — E06 UNIT IN SAFEGUARD MODE REMOVE AND REATTACH BATTERY	<p>The error indications (E01 — E06) show what type of malfunction has occurred. When an error indication appears, the camcorder turns off automatically. Remove the power supply (battery, etc.) and wait a few minutes for the indication to clear. When it does, you can resume using the camcorder. If the indication remains, consult your nearest JVC dealer.</p>

When using the AC Power Adapter/Charger in areas other than the USA

- The provided AC Power Adapter/Charger features automatic voltage selection in the AC range from 110 V to 240 V.

USING HOUSEHOLD AC PLUG ADAPTER

In case of connecting the unit's power cord to an AC wall outlet other than American National Standard C73 series type use an AC plug adapter, called a "Siemens Plug", as shown. For this AC plug adapter, consult your nearest JVC dealer.

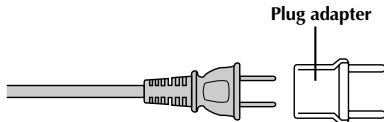

General Battery Precautions

If the remote control is not functioning even if it is being operated correctly, the batteries are exhausted. Replace them with fresh ones.

Use only the following batteries: AAA (R03) size x 2

Please make note of the following rules for battery use. When misused, the batteries can leak or explode.

1. When replacing batteries, refer to page 66.
2. **Do not** use any different size of batteries from those specified.
3. Be sure to install batteries in the correct direction.
4. **Do not** use rechargeable batteries.
5. **Do not** expose the batteries to excessive heat as they can leak or explode.
6. **Do not** dispose of the batteries in a fire.
7. Remove the batteries from the unit if it is to be stored for an extended period to avoid battery leakage which can cause malfunctions.

Battery Packs

The supplied battery pack is a lithium-ion battery. Before using the supplied battery pack or an optional battery pack, be sure to read the following cautions:

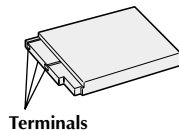

1. To avoid hazards . . .

- **do not** burn.
- **do not** short-circuit the terminals.
- **do not** modify or disassemble.
- **do not** expose the battery to temperatures exceeding 60°C (140°F), as this may cause the battery to overheat, explode or catch fire.
- use only specified chargers.

2. To prevent damage and prolong service life . . .

- **do not** subject to unnecessary shock.
- charge in an environment where temperatures are within the tolerances shown in the chart below. This is a chemical reaction type battery—cooler temperatures impede chemical reaction, while warmer temperatures can prevent complete charging.
- store in a cool, dry place. Extended exposure to high temperatures will increase natural discharge and shorten service life.
- fully charge and then fully discharge the battery every 6 months when storing the battery pack over a long period time.
- remove from charger or powered unit when not in use, as some machines use current even when switched off.

NOTES:

- It is normal for the battery pack to be warm after charging, or after use.

Temperature Range Specifications

Charging 10°C to 35°C (50°F to 95°F)

Operation 0°C to 40°C (32°F to 104°F)

Storage -10°C to 30°C (14°F to 86°F)

- Recharging time is based on room temperature of 20°C (68°F).
- The lower the temperature, the longer recharging takes.

Cassettes

To properly use and store your cassettes, be sure to read the following cautions:

1. During use . . .

- make sure the cassette bears the Mini DV mark.
- be aware that recording onto precorded tapes automatically erases the previously recorded video and audio signals.
- make sure the cassette is positioned properly when inserting.
- do not load and unload the cassette repeatedly without allowing the tape to run at all. This slackens the tape and can result in damage.
- do not open the front tape cover. This exposes the tape to fingerprints and dust.

2. Store cassettes . . .

- away from heaters or other heat sources.
- out of direct sunlight.
- where they won't be subject to unnecessary shock or vibration.
- where they won't be exposed to strong magnetic fields (such as those generated by motors, transformers or magnets).
- vertically, in their original cases.

MultiMediaCards

To properly use and store your MultiMediaCards, be sure to read the following cautions:

1. **During use . . .**
 - make sure the MultiMediaCard bears the MultiMediaCard mark.
 - make sure the MultiMediaCard is positioned properly when inserting.
2. **While the MultiMediaCard is being accessed (during recording, playback, deletion, initialization, etc.) . . .**
 - never unload the MultiMediaCard and never turn off the camcorder.
3. **Store MultiMediaCards . . .**
 - away from heaters or other heat sources.
 - out of direct sunlight.
 - where they won't be subject to unnecessary shock or vibration.
 - where they won't be exposed to strong magnetic fields (such as those generated by motors, transformers or magnets).

LCD Monitor

1. **To prevent damage to the LCD monitor, DO NOT . . .**
 - push it strongly or apply any shocks.
 - place the camcorder with the LCD monitor on the bottom.
2. **To prolong service life . . .**
 - avoid rubbing it with coarse cloth.
3. **Be aware of the following phenomena for LCD monitor use.**

These are not malfunctions:

 - While using the camcorder, the surface around the LCD monitor and/or the back of the LCD monitor may heat up.
 - If you leave power on for a long time, the surface around the LCD monitor becomes hot.

Main Unit

1. **For safety, DO NOT . . .**
 - open the camcorder's chassis.
 - disassemble or modify the unit.
 - short-circuit the terminals of the battery pack. Keep it away from metallic objects when not in use.
 - allow inflammables, water or metallic objects to enter the unit.
 - remove the battery pack or disconnect the power supply while the power is on.
 - leave the battery pack attached when the camcorder is not in use.
2. **Avoid using the unit . . .**
 - in places subject to excessive humidity or dust.
 - in places subject to soot or steam such as near a cooking stove.

- in places subject to excessive shock or vibration.
- near a television set.
- near appliances generating strong magnetic or electric fields (speakers, broadcasting antennas, etc.).
- in places subject to extremely high (over 40°C or 104°F) or extremely low (under 0°C or 32°F) temperatures.

3. **DO NOT leave the unit . . .**
 - in places of over 50°C (122°F).
 - in places where humidity is extremely low (below 35%) or extremely high (above 80%).
 - in direct sunlight.
 - in a closed car in summer.
 - near a heater.
4. **To protect the unit, DO NOT . . .**
 - allow it to become wet.
 - drop the unit or strike it against hard objects.
 - subject it to shock or excessive vibration during transportation.
 - keep the lens directed at extremely bright objects for long periods.
 - expose the lens to direct sunlight.
 - carry it by holding the LCD monitor or the viewfinder.
 - swing it excessively when using the hand strap or the grip.
 - swing the soft camera case excessively when the camcorder is inside it.
5. **Dirty heads can cause the following problems:**

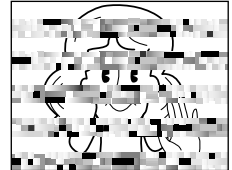

- No picture during playback.
- Blocks of noise appear during playback.
- During recording, the Head Clog Warning indicator "⊗" appears.

In such cases, use an optional cleaning cassette. Insert it and play back. If the cassette is used more than once consecutively, damage to the video heads may result. After the camcorder plays back for about 20 seconds, it stops automatically. Also refer to the cleaning cassette's instructions.

If, after using the cleaning cassette, the problems still exist, consult your nearest JVC dealer. Mechanical moving parts used to move the video heads and video tape tend to become dirty and worn out over time. In order to maintain a clear picture at all times, periodic check-ups are recommended after using the unit for about 1,000 hours. For periodic check-ups please consult your nearest JVC dealer.

How To Handle A CD-ROM

- Take care not to soil or scratch the mirror surface (opposite to the printed surface). Do not write anything or put a sticker on either the front or back surface. If the CD-ROM gets dirty, gently wipe it with a soft cloth outward from the center hole using a circular motion.
- Do not use conventional disc cleaners or cleaning spray.
- Do not bend the CD-ROM or touch its mirror surface.
- Do not store your CD-ROM in a dusty, hot or humid environment. Keep it away from direct sunlight.

About moisture condensation . . .

- You have observed that pouring a cold liquid into a glass will cause drops of water to form on the glass' outer surface. This same phenomenon occurs on the head drum of a camcorder when it is moved from a cool place to a warm place, after heating a cold room, under extremely humid conditions or in a place directly subjected to the cool air from an air conditioner.
- Moisture on the head drum can cause severe damage to the video tape, and can lead to internal damage to the camcorder itself.

Serious malfunctioning

If malfunctioning occurs, stop using the unit immediately and consult your local JVC dealer.

The camcorder is a microcomputer-controlled device. External noise and interference (from a TV, a radio, etc.) might prevent it from functioning properly. In such cases, first disconnect its power supply unit (battery pack, AC Power Adapter/Battery Charger, etc.) and wait a few minutes and then re-connect it and proceed as usual from the beginning.

Declaration of Conformity

Model Number : CU-V502U
Trade Name : JVC
Responsible party : JVC AMERICAS CORP.
Address : 1700 Valley Road Wayne,
 N. J. 07470
Telephone Number : 973-315-5000

This device complies with Part 15 of FCC Rules. Operation is subject to the following two conditions:

(1) This device may not cause harmful interference, and (2) this device must accept any interference received, including interference that may cause undesired operation.







Change or modifications not approved by the party responsible for compliance could void the user's authority to operate the equipment. This equipment has been tested and found to comply with the limits for a Class B digital device, pursuant to Part 15 of the FCC Rules. These limits are designed to provide reasonable protection against harmful interference in a residential installation. This equipment generates, uses, and can radiate radio frequency energy and, if not installed and used in accordance with the instructions, may cause harmful interference to radio communications. However, there is no guarantee that interference will not occur in a particular installation. If this equipment does cause harmful interference to radio or television reception, which can be determined by turning the equipment off and on, the user is encouraged to try to correct the interference by one or more of the following measures:

- Reorient or relocate the receiving antenna.
- Increase the separation between the equipment and receiver.
- Connect the equipment into an outlet on a circuit different from that to which the receiver is connected.
- Consult the dealer or an experienced radio/TV technician for help.







This Class B digital apparatus complies with Canadian ICES-003.

Cet appareil numérique de la classe B est conforme à la norme NMB-003 du Canada.







A

- AC Power Adapter/Charger  pg. 8, 9
- Animation  pg. 35
- Audio Dubbing  pg. 76
- Auto Date  pg. 31
- Auto Focus  pg. 27
- Auto Playback  pg. 47
- Auto Shut off  pg. 19, 21, 42













B

- Backlight Compensation  pg. 40
- Battery Low  pg. 91
- Battery Pack  pg. 8, 9, 93
- Beep/Tally  pg. 29
- Blank Search  pg. 45
- Brighten The LCD Monitor  pg. 18
- Built-in Clock's Lithium Battery  pg. 11



C

- Channels (Left/Right)  pg. 44
- Charge The Battery Pack  pg. 8
- Cinema  pg. 30
- Classic Film  pg. 38
- Clean The Camcorder  pg. 78
- Connections  pg. 9, 58, 60 – 63, 71

D

- Darken The LCD Monitor  pg. 18
- Date/Time Display  pg. 31, 43, 44
- Date/Time Settings  pg. 11
- Deleting Files  pg. 51
- Demonstration Mode  pg. 7, 30
- Digital Sound Effect  pg. 39
- Digital Zoom  pg. 22, 29
- DIS (Digital Image Stabilizer)  pg. 30
- Diopter Adjustment  pg. 10
- DPOF (Digital Print Order Format)  pg. 56
- Dual Shooting  pg. 26
- Dubbing  pg. 62 – 65



E

- E-Mail Clip Recording  pg. 46
- Erase Protection  pg. 12
- Exposure Control  pg. 40







F

- Fade-In/Out  pg. 36, 37
- Fast-Forward The Tape  pg. 42
- 5-second recording mode  pg. 35
- Flash  pg. 32, 33
- Frame-By-Frame Playback  pg. 42, 68

G

- Gain Up  pg. 29
- Grip Adjustment  pg. 10



I

- Icons  pg. 29 – 31
- Index Playback  pg. 49
- Index Screen  pg. 48
- Initialize A MultiMediaCard  pg. 52
- Iris  pg. 40
- Iris Lock  pg. 40











J

- Journalistic Shooting  pg. 19

L

- LCD monitor/Viewfinder
 - Indications  pg. 88 – 92
- Load A Tape  pg. 12

M

- Manual Focus  pg. 27
- Menu Screen, CAMERA MENU  pg. 29
- Menu Screen, DISPLAY MENU  pg. 31, 43
- Menu Screen, MANUAL MENU  pg. 30, 31
- Menu Screen, MEMORY MENU  pg. 50
- Menu Screen, VIDEO MENU  pg. 43
- MODE Dial Position  pg. 17
- Monotone  pg. 38
- Motor Drive Mode  pg. 20
- MultiMediaCard  pg. 14, 94

O

- Operation Switch Position  pg. 16

P

Picture Quality/Size Mode	☞ pg. 15
Picture Wipe/Dissolve	☞ pg. 36, 37
Playback Special Effects	☞ pg. 69
Playback Zoom	☞ pg. 68
POWER Switch Position	☞ pg. 16
Print Frame Deletion	☞ pg. 54, 55
Printer	☞ pg. 61
Program AE With Special Effects	☞ pg. 38
Progressive Mode	☞ pg. 24, 25
Progressive Wide	☞ pg. 30
Protecting Files	☞ pg. 50
Provided Accessories	☞ pg. 6

R

Random Assemble Editing	☞ pg. 70 – 75
Record-Standby	☞ pg. 18
Recording Mode	☞ pg. 13
Red-Eye Reduction	☞ pg. 32
Remote Control	☞ pg. 66
Rewind The Tape	☞ pg. 42

S

Self-Recording	☞ pg. 19
Self-Timer	☞ pg. 34
Sepia	☞ pg. 38
Set Remote Control/VCR Code	☞ pg. 70
Shooting Mode, DUAL	☞ pg. 17
Shooting Mode, DSC	☞ pg. 17
Shuttle Search	☞ pg. 42
Shutter Speed	☞ pg. 38
Slow-Motion Playback	☞ pg. 68
Slow Shutter	☞ pg. 38
Snapshot	☞ pg. 20, 21, 26
Snapshot Mode	☞ pg. 20, 21
Sound Mode	☞ pg. 29, 43, 44
Speaker Volume	☞ pg. 42
Specifications	☞ pg. 98, 99
Squeeze	☞ pg. 30
Still Playback	☞ pg. 42
Strobe	☞ pg. 38
Superimposing A Print Frame	☞ pg. 53

T

Tele Macro	☞ pg. 30
Time Code	☞ pg. 23, 31, 43, 44
Tripod Mounting	☞ pg. 10
Twilight	☞ pg. 38

U

Unload A Tape	☞ pg. 12
---------------------	----------

V

Video Echo	☞ pg. 38
------------------	----------

W



White Balance	☞ pg. 41
Wide Mode	☞ pg. 30
Wind Cut	☞ pg. 31
Wipe In/Out	☞ pg. 36, 37

Z

Zooming	☞ pg. 22
---------------	----------

Camcorder

For General

Power supply	: DC 6.3 V  (Using AC Power Adapter/Charger) DC 7.2 V  (Using battery pack)
Power consumption	
LCD monitor off, viewfinder on	: Approx. 4.6 W
LCD monitor on, viewfinder off	: Approx. 5.5 W
Dimensions (W x H x D)	: 51 mm x 125 mm x 97 mm (2-1/16" x 4-15/16" x 3-7/8") (with the LCD monitor closed and the viewfinder pushed back in)
Weight	: Approx. 510 g (1.2 lbs) (without cassette, MultiMediaCard and battery) Approx. 585 g (1.3 lbs) (incl. cassette, MultiMediaCard and battery)
Operating temperature	: 0°C to 40°C (32°F to 104°F)
Operating humidity	: 35% to 80%
Storage temperature	: -20°C to 50°C (-4°F to 122°F)
Pickup	: 1/4" CCD (Progressive Scan)
Lens	: F 1.8, f = 3.8 mm to 38 mm, 10:1 power zoom lens
Filter diameter	: ø27 mm
LCD monitor	: 2.5" diagonally measured, LCD panel/TFT active matrix system
Viewfinder	: Electronic viewfinder with 0.44" color LCD
Speaker	: Monaural

For Digital Video Camera

Format	: DV format (SD mode)
Signal format	: NTSC standard
Recording/Playback format	: Video: Digital component recording Audio: PCM digital recording, 32 kHz 4-channel (12-bit), 48 kHz 2-channel (16-bit)
Cassette	: Mini DV cassette
Tape speed	: SP: 18.8 mm/s LP: 12.5 mm/s
Maximum recording time (using 80 min. cassette)	: SP: 80 min. LP: 120 min.

For Digital Still Camera

Storage media	: MultiMediaCard
Compression system	: JPEG (compatible)
File size	: 2 modes (XGA: 1024 x 768 pixels/VGA: 640 x 480 pixels)
Picture quality	: 2 modes (FINE/STANDARD)
Approximate number of storable images (with the provided MultiMediaCard [8 MB], with Sound Effects pre-stored)	
FINE	: 46 (VGA), 21 (XGA)
STANDARD	: 133 (VGA), 64 (XGA)
(with an optional MultiMediaCard [4 MB])	
FINE	: 26 (VGA), 12 (XGA)
STANDARD	: 76 (VGA), 36 (XGA)
(with an optional MultiMediaCard [8 MB])	
FINE	: 54 (VGA), 24 (XGA)
STANDARD	: 155 (VGA), 75 (XGA)

For Connectors

Video output	: 1 V (p-p), 75 Ω , analog
Audio output	: 300 mV (rms), 1 k Ω , analog, stereo
DV Input/output	: 4-pin, IEEE 1394 compliant
Headphone output	: \varnothing 3.5 mm, stereo

AC Power Adapter/Charger AA-V51U

Power requirement	
U.S.A. and Canada	: AC 120 V \sim , 60 Hz
Other countries	: AC 110 V to 240 V \sim , 50 Hz/60 Hz
Power consumption	: 23 W
Output	
Charge	: DC 7.2 V \equiv , 0.77 A
VTR	: DC 6.3 V \equiv , 1.8 A
Dimensions (W x H x D)	: 68 mm x 45 mm x 110 mm (2-11/16" x 1-13/16" x 4-3/8")
Weight	: Approx. 254.5 g (0.57 lbs)

Docking Station CU-V502U**For General**

Dimensions (W x H x D)	: 55 mm x 36 mm x 107 mm (2-3/16" x 1-7/16" x 4-1/4")
Weight	: Approx. 89.9 g (0.2 lbs)

For Connectors

S-Video	: Y: 1 V (p-p), 75 Ω , analog output C: 0.29 V (p-p), 75 Ω , analog output
Video	: 1 V (p-p), 75 Ω , analog output
Audio	: 300 mV (rms), 1 k Ω , analog output
JLIP (EDIT)	: \varnothing 3.5 mm, 4-pole, mini-head jack (compatible with RC-5325 plug)
PC (DIGITAL STILL)	: \varnothing 2.5 mm, 3-pole
External microphone input	: 506 μ V (rms), high impedance unbalanced with \varnothing 3.5 mm (stereo)
PRINTER	: For an optional video printer equipped with a PRINT DATA connector

Specifications shown are for SP mode unless otherwise indicated. E & O.E. Design and specifications subject to change without notice.

JVC

VICTOR COMPANY OF JAPAN, LIMITED